

Outdoor
Living
2024
2025

POINT.

INDEX

CONTEMPORÁNEO

LEGACY 34

CITY 52

KUBIK 60

KAHN 76

LONG ISLAND 80

SUMMER 86

NECK 96

ORIGIN 104

PARALEL 120

WEAVE 134

HAMP & ROUND 152

FUP 158

PAL 160

HERITAGE 166

ARC 178

LIS 182

KHAI 184

BAY 188

COLORS 192

SUNSET 194

CLÁSICO

ALGA 202

CHARLESTON 206

SAGRA 210

CADDIE 212

HAVANA 214

ARENA 218

BREDA 222

BRUMAS 226

ROMANTIC 230

TOPS 235

UMBRELLAS 243

Ombra, Beach & Roma

DETALLES

TÉCNICOS 251

ACABADOS Y

MANTENIMIENTO 339

TELAS 361

CONTEMPORARY

LEGACY 34

CITY 52

KUBIK 60

KAHN 76

LONG ISLAND 80

SUMMER 86

NECK 96

ORIGIN 104

PARALEL 120

WEAVE 134

HAMP & ROUND 152

FUP 158

PAL 160

HERITAGE 166

ARC 178

LIS 182

KHAI 184

BAY 188

COLORS 192

SUNSET 194

CLASSIC

ALGA 202

CHARLESTON 206

SAGRA 210

CADDIE 212

HAVANA 214

ARENA 218

BREDA 222

BRUMAS 226

ROMANTIC 230

TOPS 235

UMBRELLAS 243

Ombra, Beach & Roma

TECHNICAL

DETAILS 251

FINISHES AND

MAINTENANCE 339

FABRICS 361

INTRODUCTION

GUIADOS POR UNA PROFUNDA CULTURA DEL DISEÑO, LA PRESERVACIÓN DE LA ARTESANÍA Y UNA APUESTA INQUEBRANTABLE POR LA INNOVACIÓN Y LA SOSTENIBILIDAD, POINT SE ERIGE COMO EMBAJADORA DEL DISEÑO ESPAÑOL Y REFERENTE INTERNACIONAL EN PROYECTOS CONTRACT Y RESIDENCIALES.

CON MÁS DE UN SIGLO DE TRAYECTORIA, HEMOS CONSTRUIDO UNA SÓLIDA REPUTACIÓN COMO PIONEROS EN LA CREACIÓN DE MOBILIARIO DE EXTERIOR, ALBERGANDO EN NUESTRO CATÁLOGO MÁS DE 300 PROPUESTAS CON SELLO DE DESTACADOS DISEÑADORES COMO MARIO RUIZ, GABRIEL TEIXIDÓ, CHRISTOPHE PILLET, FRANCESC RIFÉ O VICENT MARTINEZ, EN COLECCIONES QUE ACAPARAN TAMBIÉN OTROS TANTOS GALARDONES. AQUÍ, LA TRADICIÓN CONVIVE CON LA ÚLTIMA TECNOLOGÍA, CREANDO MUEBLES QUE NO SOLO CAUTIVAN CON SU ESTÉTICA, SINO QUE TAMBIÉN GARANTIZAN UN CONFORT Y DURABILIDAD EXCEPCIONAL.

LED BY A DEEP-SEATED CULTURE OF DESIGN, THE PRESERVATION OF CRAFTSMANSHIP AND A FIRM COMMITMENT TO INNOVATION AND SUSTAINABILITY, POINT STANDS AS AN AMBASSADOR OF SPANISH DESIGN AND AN INTERNATIONAL REFERENCE IN CONTRACT AND RESIDENTIAL PROJECTS.

WITH MORE THAN A CENTURY OF EXPERIENCE, WE HAVE BUILT UP A SOLID REPUTATION AS PIONEERS IN THE CREATION OF OUTDOOR FURNITURE. A BROWSE THROUGH OUR CATALOGUE REVEALS MORE THAN 300 PROPOSALS THAT CARRY THE HALLMARK OF RENOWNED DESIGNERS SUCH AS MARIO RUIZ, GABRIEL TEIXIDÓ, CHRISTOPHE PILLET, FRANCESC RIFÉ AND VICENT MARTINEZ, IN COLLECTIONS THAT HAVE ALSO WON MANY AWARDS. HERE, TRADITION AND THE LATEST TECHNOLOGY COEXIST, CREATING FURNITURE THAT NOT ONLY PUSHES THE BOUNDARIES OF AESTHETICS AND FUNCTIONALITY, BUT ALSO GUARANTEES EXCEPTIONAL COMFORT AND DURABILITY.

PASIÓN POR EL DISEÑO Y LA ARTESANÍA

NUESTRA HISTORIA HA ESTADO INTRÍNECAMENTE VINCULADA A LA ESENCIA DEL MEDITERRÁNEO Y NUESTRA APASIONADA DEDICACIÓN A LA ARTESANÍA. TODO COMENZÓ -HACE YA MÁS DE 100 AÑOS- CON UN INQUIETO Y AVENTURERO JOSÉ PONS PEDRO, QUIEN DEJÓ SU TIERRA NATAL PARA APRENDER EL OFICIO EN ARGENTINA. AÑOS DESPUÉS, REGRESÓ A SU LUGAR DE ORIGEN PARA FUNDAR UN MODESTO TALLER ARTESANO DE TRENZADO DEL MIMBRE. ESTA TIERRA MEDITERRÁNEA, CON SU RIQUEZA CULTURAL Y SUS TRADICIONES, HA SIDO LA FUENTE DE NUESTRA INSPIRACIÓN Y TESTIMONIO DE NUESTRA EVOLUCIÓN A MARCA INTERNACIONAL, PRESENTE EN MÁS DE 70 PAÍSES Y FIEL ALIADA EN LOS ESPACIOS EXTERIORES DE LAS CADENAS HOTELERAS MÁS PRESTIGIOSAS. LA FAMILIA, LA ARTESANÍA Y LA PROMOCIÓN DEL TALENTO ESTÁN EN LA BASE DE ESTA CRÓNICA DE ÉXITO.

CELEBRANDO MÁS DE UN SIGLO DE HISTORIA, NUESTRA PROFUNDA CONEXIÓN CON LA ARTESANÍA Y LA PASIÓN POR EL DISEÑO SE MANTIENEN SÓLIDAS EN EL CORAZÓN DE POINT. EN 2020, RECIBIMOS CON ORGULLO EL PREMIO NACIONAL DE DISEÑO 2019 OTORGADO POR EL MINISTERIO DE CIENCIA, INNOVACIÓN Y UNIVERSIDADES DE ESPAÑA, EN RECONOCIMIENTO A NUESTRA VALIOSA CONTRIBUCIÓN A LA MEJORA DE LA SOCIEDAD Y LA CALIDAD DE VIDA DE LAS PERSONAS.

NUESTRA EXPERIENCIA EN LA FABRICACIÓN DE PIEZAS Y EL RESPETO POR LA ARTESANÍA SIGUEN SIENDO PILARES ESENCIALES DE NUESTRO PROCESO CREATIVO. CADA SOFÁ TRENZADO DE POINT DEMANDA CUARENTA HORAS DE METICULOSO TRABAJO ARTESANAL, MIENTRAS QUE CADA SILLA REQUIERE NO MENOS DE SEIS. ADEMÁS, MANTENEMOS UN ENFOQUE CONTINUO EN LA INNOVACIÓN Y LA SOSTENIBILIDAD, QUE GUÍA NUESTRO PROCESO CREATIVO Y QUE NOS HA PERMITIDO DESARROLLAR NUEVOS MATERIALES, INCLUYENDO FIBRAS Y MADERAS TECNOLÓGICAS PATENTADAS. ESTE COMPROMISO CONSTANTE CON LA ARTESANÍA Y LA INNOVACIÓN NOS HA LLEVADO A MANTERNOS A LA VANGUARDIA DE LA INDUSTRIA DEL DISEÑO Y EL MOBILIARIO DE EXTERIOR.

PASSION FOR DESIGN AND CRAFTSMANSHIP

OUR HISTORY HAS BEEN INTRINSICALLY LINKED TO THE ESSENCE OF THE MEDITERRANEAN AND OUR PASSIONATE DEDICATION TO CRAFTSMANSHIP. IT ALL BEGAN -MORE THAN 100 YEARS AGO- WITH A YOUNG ADVENTURER, JOSÉ PONS PEDRO, WHO LEFT HIS HOMETLAND TO LEARN THE CRAFT IN ARGENTINA. YEARS LATER, HE RETURNED TO HIS PLACE OF ORIGIN AND SET UP A MODEST ARTISAN WICKER WEAVING WORKSHOP. THIS MEDITERRANEAN LAND, WITH ITS RICH CULTURE AND TRADITIONS, HAS BEEN THE SOURCE OF OUR INSPIRATION AND TESTIMONY TO OUR EVOLUTION INTO AN INTERNATIONAL BRAND THAT IS PRESENT IN MORE THAN 70 COUNTRIES AND A LOYAL ALLY IN THE OUTDOOR SPACES OF THE MOST PRESTIGIOUS HOTEL CHAINS. FAMILY, CRAFTSMANSHIP AND THE PROMOTION OF TALENT FORM THE FOUNDATIONS OF THIS CHRONICLE OF SUCCESS.

CELEBRATING MORE THAN A CENTURY OF HISTORY, OUR DEEP CONNECTION TO CRAFTSMANSHIP AND PASSION FOR DESIGN REMAIN SOLIDLY AT THE HEART OF POINT. IN 2020, WE PROUDLY RECEIVED THE 2019 NATIONAL DESIGN AWARD FROM THE SPANISH MINISTRY OF SCIENCE, INNOVATION AND UNIVERSITIES IN RECOGNITION OF OUR VALUABLE CONTRIBUTION TO IMPROVING THE QUALITY OF LIFE OF SOCIETY AND ITS PEOPLE.

OUR FURNITURE MANUFACTURING EXPERTISE AND RESPECT FOR CRAFTSMANSHIP REMAIN ESSENTIAL PILLARS OF OUR CREATIVE PROCESS. EACH OF POINT'S WOVEN SOFAS INVOLVES FORTY HOURS OF METICULOUS CRAFTSMANSHIP, WHILE EACH CHAIR REQUIRES NO LESS THAN SIX. IN ADDITION, WE MAINTAIN A CONSTANT FOCUS ON INNOVATION AND SUSTAINABILITY, WHICH GUIDES OUR CREATIVE PROCESS AND HAS ALLOWED US TO DEVELOP NEW MATERIALS, INCLUDING PATENTED TECHNOLOGICAL FIBERS AND WOODS. THANKS TO THIS ONGOING COMMITMENT TO CRAFTSMANSHIP AND INNOVATION, WE REMAIN AT THE FOREFRONT OF THE OUTDOOR FURNITURE AND DESIGN INDUSTRY.

POINT AND SUSTAINABILITY



En POINT, la sostenibilidad no es solo una meta, es un camino que recorreremos con compromiso y dedicación, desempeñando un papel fundamental en nuestra estrategia empresarial. Durante más de diez décadas, esta filosofía ha perdurado y se ha transmitido a través de cuatro generaciones, guiando nuestra misión de crear productos de calidad respetuosos con el medioambiente.

La durabilidad ha sido -y es- una prioridad para nuestra empresa; es la esencia de la sostenibilidad. Creemos que no hay nada más sostenible que un producto que pueda perdurar generación tras generación. Desde 1920, hemos creado muebles que resisten el paso del tiempo, utilizando materiales duraderos, técnicas de fabricación expertas y diseños atemporales. Hemos desarrollado un protocolo interno de diseño que exige trabajar con materiales 100% reciclables -para que todos tengan una segunda vida útil- y que, tanto en los procesos de fabricación como en el tratamiento de residuos generados, nuestros productos no causen impactos ambientales.

At POINT, sustainability is not just a goal, it is a path we walk with commitment and dedication, playing a fundamental role in our business strategy. For more than ten decades, this philosophy has persisted and been transmitted through four generations, shaping our mission to create high-quality products that respect the environment.

Durability has been -and continues to be- a priority for our company; it is the essence of sustainability. We believe there is nothing more sustainable than a product that can last from generation to generation. Since 1920, we have been creating furniture that stands the test of time, using durable materials, expert manufacturing techniques and timeless designs. We have developed an internal design protocol that requires us to work with 100% recyclable materials -so that they all have a second life- and to ensure that our products have no impact on the environment, either in the manufacturing process or in disposing of the waste generated.

DISEÑO ECO-CONSCIENTE

Fieles a nuestra filosofía de respeto por el medioambiente, buscamos soluciones productivas que toman la base del ecodiseño, comprometiéndonos con el uso de materiales sostenibles en todos nuestros productos. La madera -teca de grado A con certificación FSC- proviene de bosques sostenibles de tala controlada. Contiene un alto nivel de aceite y gomas naturales, que le otorga una alta flexibilidad y durabilidad. El aluminio también abraza nuestro principio de durabilidad, siendo altamente resistente y 100% reciclable, traducándose en una reducción considerable de las emisiones de carbono y en un menor agotamiento de los recursos naturales.

En POINT, la selección de los tejidos no solo tiene un sentido estético, también lo tiene funcional y comprometido con el medioambiente. Todos son lavables, reversibles, duraderos y de alta calidad. Así se limita el reemplazo y los residuos. Trabajamos con proveedores que nos suministran materiales reciclados procedentes de fibras, hilo y tela y con empresas que convierten los sobrantes de tela en materiales nuevos. Los tejidos que empleamos en nuestras piezas cuentan con certificados que acreditan el uso de sustancias no dañinas para la salud o el entorno. Disponemos también de certificados de calidad de nuestros productos, como el Certificado de Ensayo de AIDIMA (el Instituto Tecnológico del Mueble), ISO 9001 o FSC, testimonio sólido de nuestra dedicación a la sostenibilidad y al bienestar de la comunidad en la que operamos.

GENERACIÓN DE ENERGÍA LIMPIA

Precursores en el consumo responsable y en el cuidado de la naturaleza, hace más de dos décadas transformamos nuestra sede central de Jalón en una planta de producción de energía limpia. El sol nos ha permitido ser autosuficientes energéticamente y generar más energía de la que necesitamos. Con una producción fotovoltaica de 371.000 kilovatios al año, conseguimos evitar la emisión a la atmósfera de 138

ECO-CONSCIOUS DESIGN

True to our philosophy of respect for the environment, we seek production solutions based on eco-design, committing ourselves to the use of sustainable materials in all our products. The wood we use -grade A teak with FSC certification- comes from sustainably managed forests. It contains a high level of natural oils and gums, which give it high flexibility and durability. Aluminum also fits with our principle of durability, as it is highly resistant and 100% recyclable, resulting in a considerable reduction of carbon emissions and less depletion of natural resources.

At POINT, the selection of fabrics is not just based on aesthetic criteria; they are also functional and environmentally conscious. They are washable, reversible, durable and of high quality, which limits replacement and waste. We work with suppliers who provide us with recycled materials made from fibers, yarn and fabric and with companies that convert leftover fabric into new materials. The fabrics we use in our pieces have certificates that confirm the use of substances that are not harmful to health or the environment. We also have quality certificates for our products, such as the AIDIMA (Technological Institute of Furniture) Test Certificate, ISO 9001 and FSC, a solid testimony of our dedication to sustainability and the well-being of the community in which we operate.

CLEAN ENERGY PRODUCTION

As some of the earliest proponents of responsible consumption and caring for nature, more than two decades ago we transformed our headquarters in Jalón into a clean energy production plant. The sun has enabled us to become energy self-sufficient, generating more energy than we need. With a photovoltaic production of 371,000 kilowatts per year, we manage to avoid the emission of 138 tons of carbon dioxide (CO₂) into the atmosphere, an amount equivalent to that produced by 50 cars in an average year.



toneladas de dióxido de carbono (CO₂), una cantidad equivalente a la que generan 50 coches de media durante un año.

PACKAGING RESPONSABLE

A pesar de nuestra clara preferencia por el uso del cartón en nuestros embalajes, para compensar el uso inevitable de plástico, colaboramos con CleanHub para retirar más de 2.000 kg de plástico de la Costa de Indonesia cada año, contribuyendo a la lucha contra la contaminación marina y la protección de nuestros océanos. De este modo, por cada kg de plástico que utilizamos en nuestros embalajes, nos comprometemos a recoger y eliminar del medioambiente una cantidad igual, colaborando también a mejorar la vida de las comunidades costeras que trabajan en su recogida.

RESPONSIBLE PACKAGING

Despite our preference for the use of cardboard in our packaging, to offset the unavoidable use of plastic, we have partnered with CleanHub to remove more than 2,000 kg of plastic from the Indonesian coast each year, contributing to the fight against marine pollution and the protection of our oceans. In this way, for every kilogram of plastic we use in our packaging, we commit to collecting and removing the same amount from the environment, while also helping to improve the lives of the coastal communities that work to collect it.

DESIGNERS

Mario Ruiz

MARIO RUIZ (ALICANTE, 1965) ES EL MAESTRO DE LA LÍNEA LIMPIA Y UNO DE LOS DISEÑADORES INDUSTRIALES MÁS PROLÍFICOS. HA HECHO DE LA SENCILLEZ Y LA FUNCIONALIDAD SU SEÑA DE IDENTIDAD. EN SU OBRA HAY UN MARCADO CARÁCTER SENSORIAL, CON MATERIALES QUE DIBUJAN LA LUZ Y EL AROMA DEL MEDITERRÁNEO. SU TRABAJO HA SIDO OBJETO DE EXPOSICIONES Y MONOGRAFÍAS POR TODO EL MUNDO. HA RECIBIDO MÁS DE 50 PREMIOS EN EUROPA Y ESTADOS UNIDOS. EN NUESTRO PAÍS, EN 2016, RECOGIÓ EL PREMIO NACIONAL DE DISEÑO DE MANOS DEL REY FELIPE VI.

MARIO RUIZ (ALICANTE, 1965) IS THE MASTER OF CLEAN LINES AND ONE OF THE MOST PROLIFIC INDUSTRIAL DESIGNERS. HE HAS MADE SIMPLICITY AND FUNCTIONALITY HIS HALLMARK. HIS WORK IS DISTINCTLY SENSORIAL, WITH MATERIALS SUGGESTIVE OF THE LIGHT AND FLAVOUR OF THE MEDITERRANEAN. HIS DESIGNS HAVE BEEN THE SUBJECT OF EXHIBITIONS AND MONOGRAPHS ALL OVER THE WORLD AND HAVE RECEIVED MORE THAN 50 AWARDS IN EUROPE AND THE UNITED STATES. IN SPAIN, HE RECEIVED THE 2016 NATIONAL DESIGN AWARD FROM KING FELIPE VI.



DESIGNERS

Gabriel Teixidó



EN SUS MÁS DE TRES DÉCADAS COMO DISEÑADOR INDUSTRIAL, GABRIEL TEIXIDÓ (BARCELONA, 1947) SE HA CONVERTIDO EN UN ACAPARADOR DE PREMIOS. ENTRE ELLOS, VARIOS ADI-FAD Y SIDI. CONOCIDO POR SUS DISEÑOS AUSTEROS Y ALEJADOS DEL EXHIBICIONISMO FORMAL, SUS PIEZAS SE CONVIERTEN EN GRANDES CLÁSICOS ALEJADOS DE TENDENCIAS PASAJERAS.

IN HIS MORE THAN THREE DECADES AS AN INDUSTRIAL DESIGNER, GABRIEL TEIXIDÓ (BARCELONA, 1947) HAS COLLECTED MANY PRIZES FOR HIS WORK, INCLUDING SEVERAL ADI-FAD AND SIDI AWARDS. KNOWN FOR HIS AUSTERE DESIGNS THAT SHY AWAY FROM FORMAL EXHIBITIONISM, HIS PIECES ARE CLASSICS THAT DO NOT OBEY PASSING TRENDS.

DESIGNERS

Christophe Pillet



DISEÑADOR TODOTERRENO -DESDE MOBILIARIO, A PRODUCTO, PASANDO POR INTERIORES-, ARQUITECTO, ESCENÓGRAFO, DIRECTOR ARTÍSTICO... CHRISTOPHE PILLET (MONTARGIS, FRANCIA, 1959) ES UNO DE LOS CREADORES MÁS INFLUYENTES DEL MOMENTO. ALGUNAS DE SUS PIEZAS SON PARTE DE LAS COLECCIONES DEL CENTRE POMPIDOU, EL CENTRE NATIONAL DES ARTS PLASTIQUES, EL MUSÉE DES ARTS DÉCORATIFS (EN PARÍS) O EL COOPER-HEWITT MUSEUM (EN NUEVA YORK).

A VERSATILE DESIGNER -FURNITURE, PRODUCT, INTERIOR DESIGN-, ARCHITECT, STAGE DESIGNER, ARTISTIC DIRECTOR, CHRISTOPHE PILLET (MONTARGIS, FRANCE, 1959) IS ONE OF THE MOST INFLUENTIAL CREATORS OF OUR TIME. SOME OF HIS PIECES ARE FOUND IN THE COLLECTIONS OF THE POMPIDOU CENTRE, THE CENTRE NATIONAL DES ARTS PLASTIQUES, THE MUSÉE DES ARTS DÉCORATIFS (IN PARIS) AND THE COOPER-HEWITT MUSEUM (IN NEW YORK).

DESIGNERS



DESDE SU NACIMIENTO EN 2006, EL ESTUDIO MILANÉS MENEGHELLO PAOLELLI NO HA PARADO DE COSECHAR LOS MÁS DESTACADOS PREMIOS INTERNACIONALES DE DISEÑO -13 RED DOT DESIGN AWARDS, UNO DE ELLOS EL «BEST OF THE BEST»; SIETE DESIGN PLUS; TRES GOOD DESIGN AWARDS; OCHO ADI DESIGN INDEX; CUATRO MENCIONES ESPECIALES EN LOS GERMAN DESIGN AWARDS Y TRES IF DESIGN AWARDS-. SUS FUNDADORES, SANDRO MENEGHELLO Y MARCO PAOLELLI (MILANESSES DEL 79), SE CONOCIERON ESTUDIANDO. COMENZARON SU TRAYECTORIA COMO DISEÑADORES DE PRODUCTO Y HOY SON ASESORES ESTRATÉGICOS QUE, COMO AFIRMAN, EMPLEAN “EL DISEÑO COMO SOLUCIÓN”.

SINCE ITS FOUNDATION IN 2006, THE MILANESE STUDIO MENEGHELLO PAOLELLI HAS CONTINUED TO COLLECT THE MOST PRESTIGIOUS INTERNATIONAL DESIGN AWARDS: 13 RED DOT DESIGN AWARDS, INCLUDING ONE “BEST OF THE BEST”; SEVEN DESIGN PLUS; THREE GOOD DESIGN AWARDS; EIGHT ADI DESIGN INDEX; FOUR SPECIAL MENTIONS AT THE GERMAN DESIGN AWARDS; AND THREE IF DESIGN AWARDS. THE FOUNDERS, SANDRO MENEGHELLO AND MARCO PAOLELLI (MILAN '79), MET DURING THEIR STUDIES AT POLITECNICO OF MILAN. THEY STARTED THEIR CAREERS AS PRODUCT DESIGNERS AND ARE NOW STRATEGIC CONSULTANTS WHO, AS THEY SAY, USE “DESIGN AS A SOLUTION”.

DESIGNERS

Meneghello Paoletti



Vicent Martínez

VICENT MARTÍNEZ (VALÈNCIA, 1949) SE HA CONVERTIDO EN UN REFERENTE EN EL PANORAMA DEL MUEBLE DE DISEÑO. EN SU LARGA TRAYECTORIA ACUMULA, ENTRE OTROS, EL PREMIO NACIONAL DE DISEÑO DE 1997. SUS CREACIONES SIEMPRE SIGUEN LA ESTÉTICA DE LA NECESIDAD HASTA EN LOS DETALLES MÁS PEQUEÑOS.

VICENT MARTÍNEZ (VALÈNCIA, 1949) HAS BECOME A REFERENCE POINT IN THE FURNITURE DESIGN SCENE. THROUGHOUT HIS LONG CAREER, HE HAS WON THE 1997 NATIONAL DESIGN AWARD, AMONG OTHER AWARDS. HIS CREATIONS ALWAYS FOLLOW THE AESTHETICS OF NECESSITY DOWN TO THE SMALLEST DETAILS.

Francesc Rifé



FRANCESC RIFÉ (BARCELONA, 1969), TANTO EN SU TRABAJO COMO DISEÑADOR O COMO INTERIORISTA, ES UN DEFENSOR DEL RACIONALISMO Y DE CENTRAR LA ATENCIÓN EN LOS DETALLES. PARTIDARIO DE NO EMPLEAR DEMASIADOS ELEMENTOS SUPERFLUOS E INNECESARIOS EN SUS PROYECTOS, HAY UNA COLECCIÓN DE TEMPLOS GASTRONÓMICOS QUE LLEVAN SU FIRMA, ENTRE LOS QUE DESTACAN LOS DISEÑADOS PARA EL CHEF RICARD CAMARENA (VALÈNCIA). TAMBIÉN SU MINIMALISMO CÁLIDO ESTÁ PRESENTE EN UNA GRAN VARIEDAD DE OFICINAS, HOTELES Y TIENDAS.

FRANCESC RIFÉ (BARCELONA, 1969) IS AN ADVOCATE OF RATIONALISM AND PAYING ATTENTION TO DETAIL, BOTH IN HIS WORK AS A DESIGNER AND AS AN INTERIOR DESIGNER. HE PREFERS NOT TO USE TOO MANY UNNECESSARY OR SUPERFLUOUS ELEMENTS IN HIS PROJECTS. VARIOUS PRESTIGIOUS RESTAURANTS HAVE USED HIS DESIGNS, INCLUDING THE CHEF RICARD CAMARENA (VALENCIA). HIS WARM MINIMALISM IS ALSO PRESENT IN A WIDE RANGE OF OFFICES, HOTELS AND SHOPS.

ESTHER CAMPOS (GATA DE GORGOS, ALICANTE, 1982) ES DISEÑADORA INDUSTRIAL. COMENZÓ SU TRAYECTORIA EN EL EQUIPO DE ALFONSO GALLEGO Y, DESDE 2005, FORMA PARTE DEL DEPARTAMENTO DE DISEÑO DE POINT. ADEMÁS DE CREAR PIEZAS Y COLECCIONES PROPIAS PARA LA MARCA, SUPERVISA LOS ASPECTOS TÉCNICOS DE TODAS LOS ELEMENTOS QUE SE PRODUCEN, FACILITANDO QUE TODAS LAS COLECCIONES REÚNAN UNAS CARACTERÍSTICAS DE CONFORT Y FUNCIONALIDAD QUE SE ADAPTAN A LOS ESTÁNDARES DE POINT.

ESTHER CAMPOS (GATA DE GORGOS, ALICANTE, 1982) IS AN INDUSTRIAL DESIGNER. SHE BEGAN HER CAREER AS PART OF ALFONSO GALLEGO'S TEAM AND, SINCE 2005, SHE HAS BEEN A MEMBER OF POINT'S DESIGN DEPARTMENT. AS WELL AS CREATING HER OWN PIECES AND COLLECTIONS FOR THE BRAND, SHE SUPERVISES THE TECHNICAL ASPECTS OF ALL THE ELEMENTS THAT ARE PRODUCED, ENSURING THAT ALL THE COLLECTIONS MEET POINT'S STANDARDS OF COMFORT AND FUNCTIONALITY.

Esther Campos



DESIGNERS

Alfonso Gallego

DISEÑADOR, DECORADOR E INTERIORISTA, ALFONSO GALLEGO (ALICANTE, 1964) LLEVA MÁS DE DOS DÉCADAS COLABORANDO CON POINT. SU LARGA TRAYECTORIA EN EL DESARROLLO DE MOBILIARIO Y SUS COLABORACIONES EN TODO EL MUNDO LO HAN CONVERTIDO EN UN EXPERTO EN LA CREACIÓN DE PIEZAS Y AMBIENTES FUNCIONALES DE GRAN BELLEZA Y ARMONÍA.

DESIGNER, DECORATOR AND INTERIOR DESIGNER ALFONSO GALLEGO (ALICANTE, 1964) HAS BEEN WORKING WITH POINT FOR MORE THAN TWO DECADES. HIS EXTENSIVE EXPERIENCE DEVELOPING FURNITURE AND HIS COLLABORATIONS WORLDWIDE HAVE MADE HIM AN EXPERT IN CREATING FUNCTIONAL PIECES AND AMBIENCES OF GREAT BEAUTY AND HARMONY.



DESIGNERS

POINT STUDIO ES EL EPICENTRO DEL DISEÑO DE NUESTRA FIRMA, DONDE SE PROYECTAN Y DESARROLLAN PIEZAS Y COLECCIONES PROPIAS. TAMBIÉN SE ANALIZA, DESDE UNA PERSPECTIVA TÉCNICA Y ESTÉTICA, LAS COLECCIONES REALIZADAS POR LOS DISEÑADORES QUE COLABORAN CON LA MARCA. ESTA SUPERVISIÓN ES IMPRESCINDIBLE EN EL PROCESO DE PRODUCCIÓN YA QUE PERMITE FABRICAR TODAS LAS PIEZAS CON LOS MISMOS PARÁMETROS DE CALIDAD Y ESTÉTICA.

POINT STUDIO IS THE EPICENTER OF OUR FIRM'S DESIGN, WHERE OUR OWN PIECES AND COLLECTIONS ARE PROJECTED AND DEVELOPED. IT ALSO ANALYZES, FROM A TECHNICAL AND AESTHETIC PERSPECTIVE, THE COLLECTIONS CREATED BY THE DESIGNERS WHO COLLABORATE WITH THE BRAND. THIS SUPERVISION IS ESSENTIAL IN THE PRODUCTION PROCESS AS IT ALLOWS US TO MANUFACTURE ALL THE PIECES WITH THE SAME PARAMETERS OF QUALITY AND AESTHETICS.

DESIGNERS

POINT
Studio

Contem—
porary

LEGACY
CITY
KUBIK
KAHN
LONG ISLAND
SUMMER
NECK
ORIGIN
PARALEL
WEAVE
HAMP & ROUND
FUP
PAL
HERITAGE
ARC
LIS
KHAI
BAY
COLORS
SUNSET

LEGACY

MARIO RUIZ

EL ARTE DE LA DISTINCIÓN

Con una estética puramente contemporánea, Legacy plantea un conjunto de piezas de mobiliario exterior capaz de integrarse en cualquier proyecto de diseño e interiorismo. “Es versátil y precisa”, sostiene Ruiz. “El propósito con ella era dar múltiples respuestas y facilitar al interiorista o arquitecto poder crear numerosas composiciones tanto en exterior como en interior. Su estética es minuciosa, y consigue crear ambientes sofisticados con cualquiera de sus dos líneas: Legacy Essence y Legacy Woven”.

Todas las piezas de la colección están elaboradas con una estructura en aluminio inyectado, incorporando materiales diferentes en respaldos y brazos que dan lugar a dos versiones con su propia personalidad. Legacy Essence se caracteriza por su sencillez y ligereza, así como por su diseño rotundo y minimalista con la estructura vista de aluminio. Por su parte, Legacy Woven, tiene la peculiaridad de que su estructura de aluminio funciona como bastidor para el desarrollo de una estudiada trama en cuerda.

Ambas versiones ofrecen opciones de personalización en brazos y frontal del asiento. Completa la colección una selección de mesas, tanto auxiliares como de centro, en diversos acabados para su tapa: porcelánico, HPL o aluminio.

CRAFTED FOR DISTINCTION

With a purely contemporary aesthetic, Legacy presents a set of outdoor furniture that can be integrated into any interior project. “It is versatile and precise”, says Ruiz. “The intention with it was to provide multiple solutions and make it easier for interior designers or architects to create numerous compositions, both outdoors and indoors. Its appearance is meticulous, and it manages to create sophisticated environments with either of its two lines: Legacy Essence and Legacy Woven.

All the pieces in the collection are made with a die-cast aluminum structure that incorporates different materials in the backs and armrests, resulting in two versions, each with their own personality. Legacy Essence is characterized by its simplicity and lightness, as well as its pure minimalist design with an exposed aluminum frame.

Legacy Woven, on the other hand, has the peculiarity that its aluminum structure serves as a frame for a carefully designed rope weave. Both versions offer customization options for the armrests and seat front. The collection also includes a selection of tables in various finishes: porcelain, HPL or aluminum.













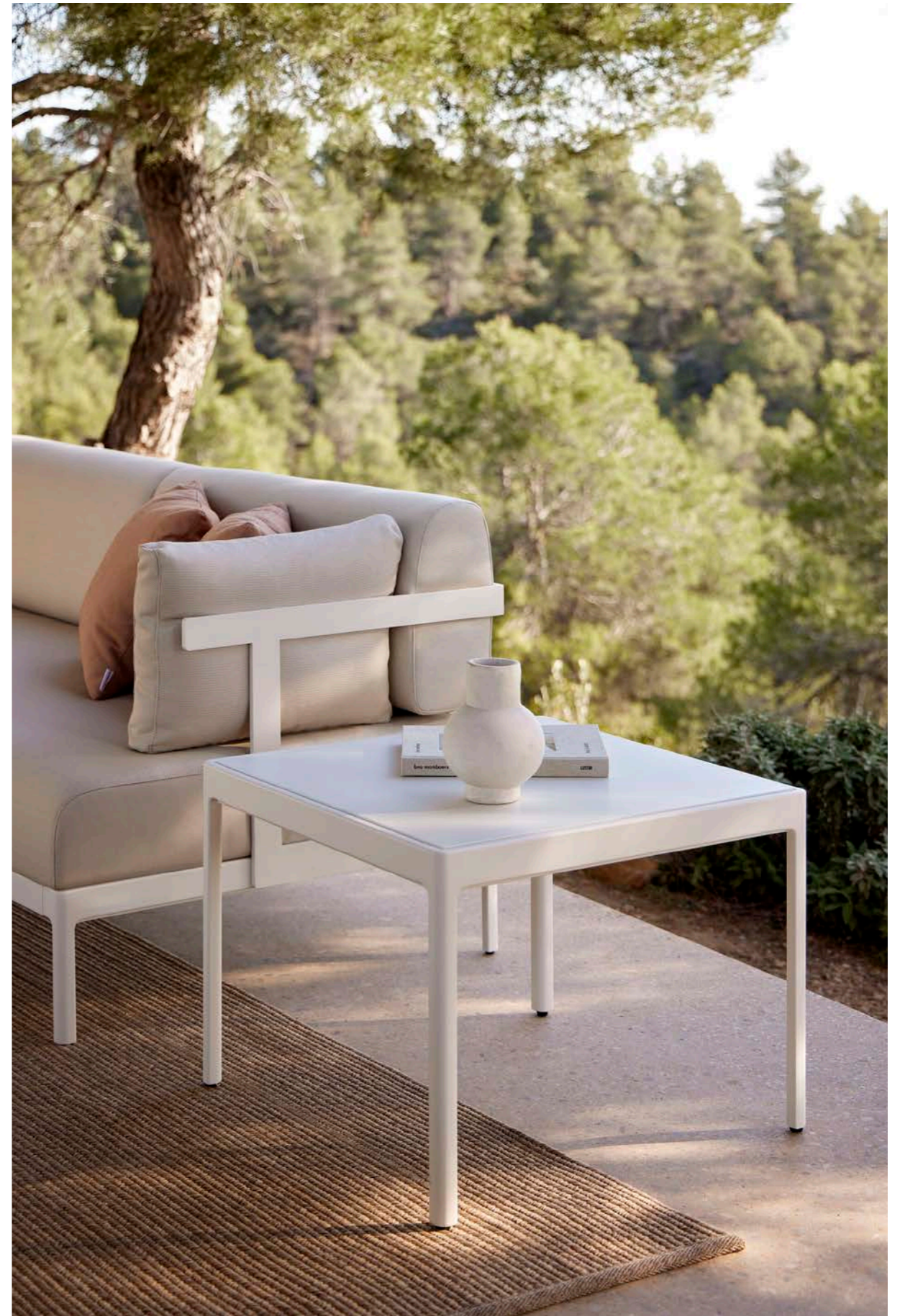





CITY

CHRISTOPHE

PILLET

LA VIDA MEDITERRÁNEA

«Con esta colección trato de describir, de manera contemporánea, un arte de vivir mediterráneo, que no tiene que ver con el tiempo. Es un universo donde el sol y la tierra se unen». Su principal característica es una estructura de aluminio pintado en polvo, con brazos en madera de teca y unos confortables y mullidos cojines. Este conjunto crea una composición de gran comodidad y armonía. Las tres piezas de la colección –un sillón, un sofá doble y uno triple–, destilan clasicismo y elegancia y sus cojines pueden ser personalizados tanto en estampados como en colores. La colección se complementa con cuatro mesas: dos mesas de centro y dos mesas de esquina.

MEDITERRANEAN LIFE

“This collection is my contemporary take on the art of Mediterranean living, which is unconnected to time. It is a universe where the sun and the earth meet”. Its main feature is a powder painted aluminum structure with teak arms and plump, comfortable cushions. These pieces create a composition of great comfort and harmony. The seats in the collection, an armchair, a double sofa and a triple sofa, exude classicism and elegance, and their cushions can be customised in terms of both prints and colours. The collection is complemented by four tables: two coffee tables and two corner tables.









KUBIK

GABRIEL

TEIXIDÓ

INTERSECCIÓN PERFECTA ENTRE DISEÑO VANGUARDISTA Y FUNCIONALIDAD

Con una línea clara y contundente en su diseño, Kubik es una oda a la funcionalidad, la belleza y el confort. Su equilibrio y precisión, nos transporta a una experiencia visual de líneas rectas, cuidadosamente estudiadas, que evocan la sensación de solidez y armonía. “El punto de partida de esta colección ha sido el nuevo material TechTeak, desarrollado por POINT, que presenta una apariencia sorprendentemente similar a la madera de teca, pero sin necesidad de mantenimiento y con una gran resistencia a los impactos”, relata Gabriel Teixidó. “Al concebir Kubik, nos propusimos abordar dos desafíos esenciales: garantizar la durabilidad en espacios exteriores y ofrecer una respuesta ecológica. A diferencia de otras colecciones, en ésta, son las características del propio material las que han marcado el diseño final”.

THE PERFECT INTERSECTION BETWEEN AVANT-GARDE DESIGN AND FUNCTIONALITY

With a clear, bold lines in its design, Kubik is an ode to functionality, beauty and comfort. Its balance and precision immerse us in a visual experience of clean, carefully studied lines that evoke a sense of solidity and harmony. “The starting point for this collection was TechTeak, the new material developed by POINT, which has a surprisingly similar appearance to teak but is maintenance-free and highly resistant to impact”, says Gabriel Teixidó. “When we designed Kubik, we wanted to respond to two essential challenges: to guarantee outdoor durability and to offer an ecological option. Unlike other collections, in this one it was the characteristics of the material itself that determined the final design”.





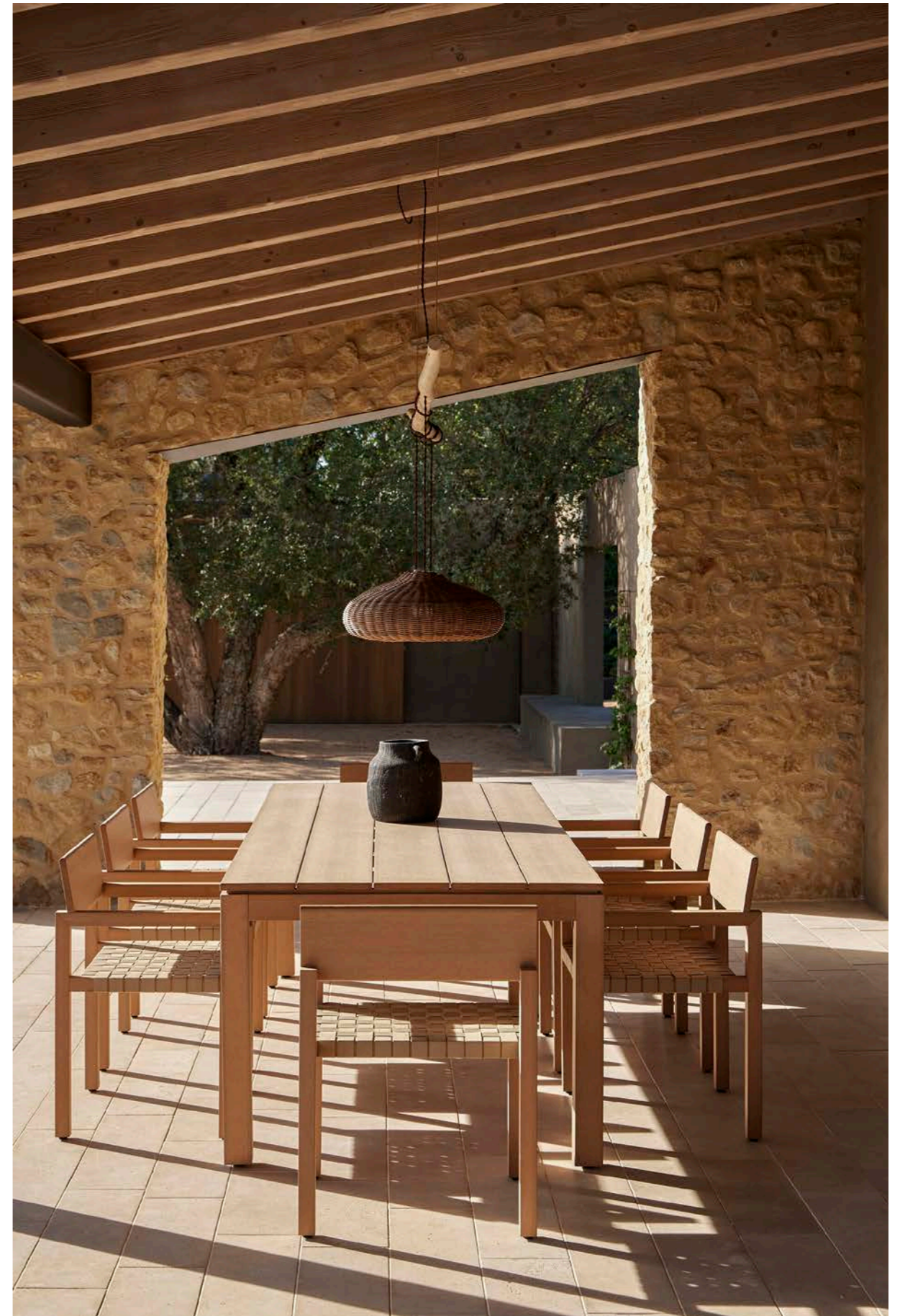
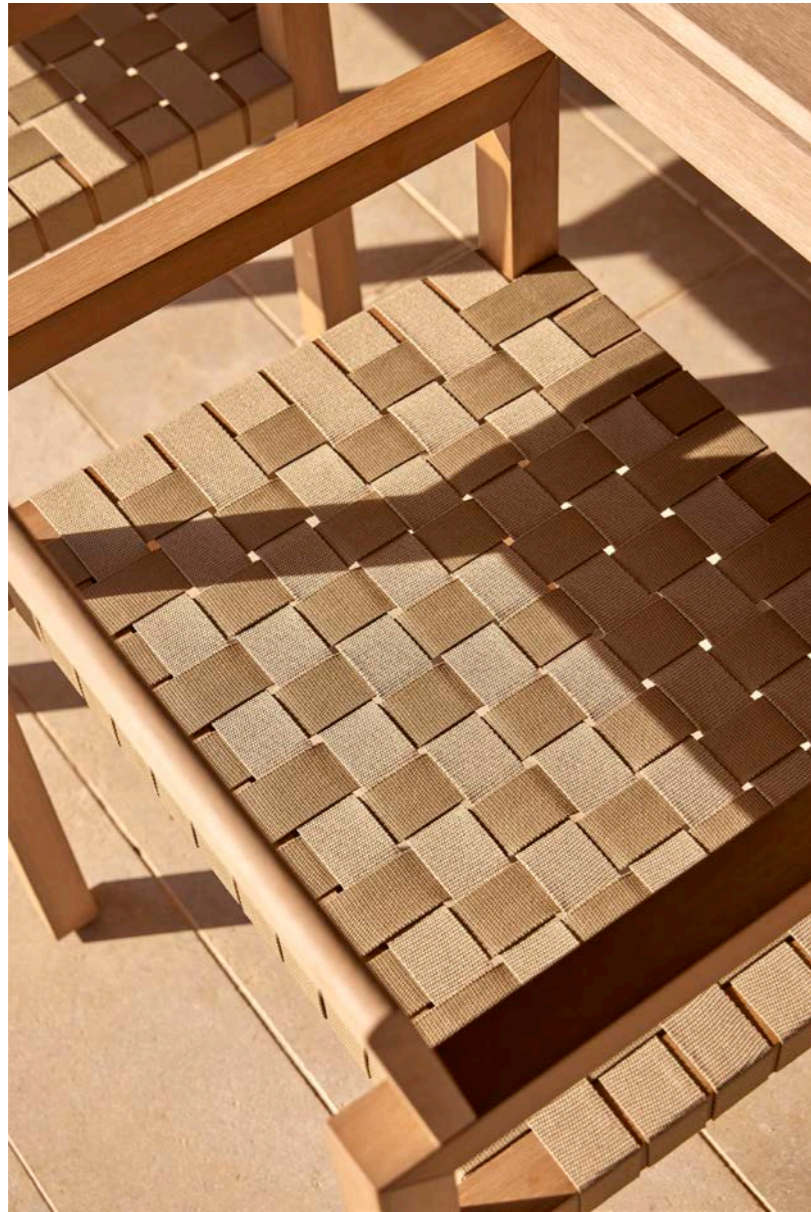



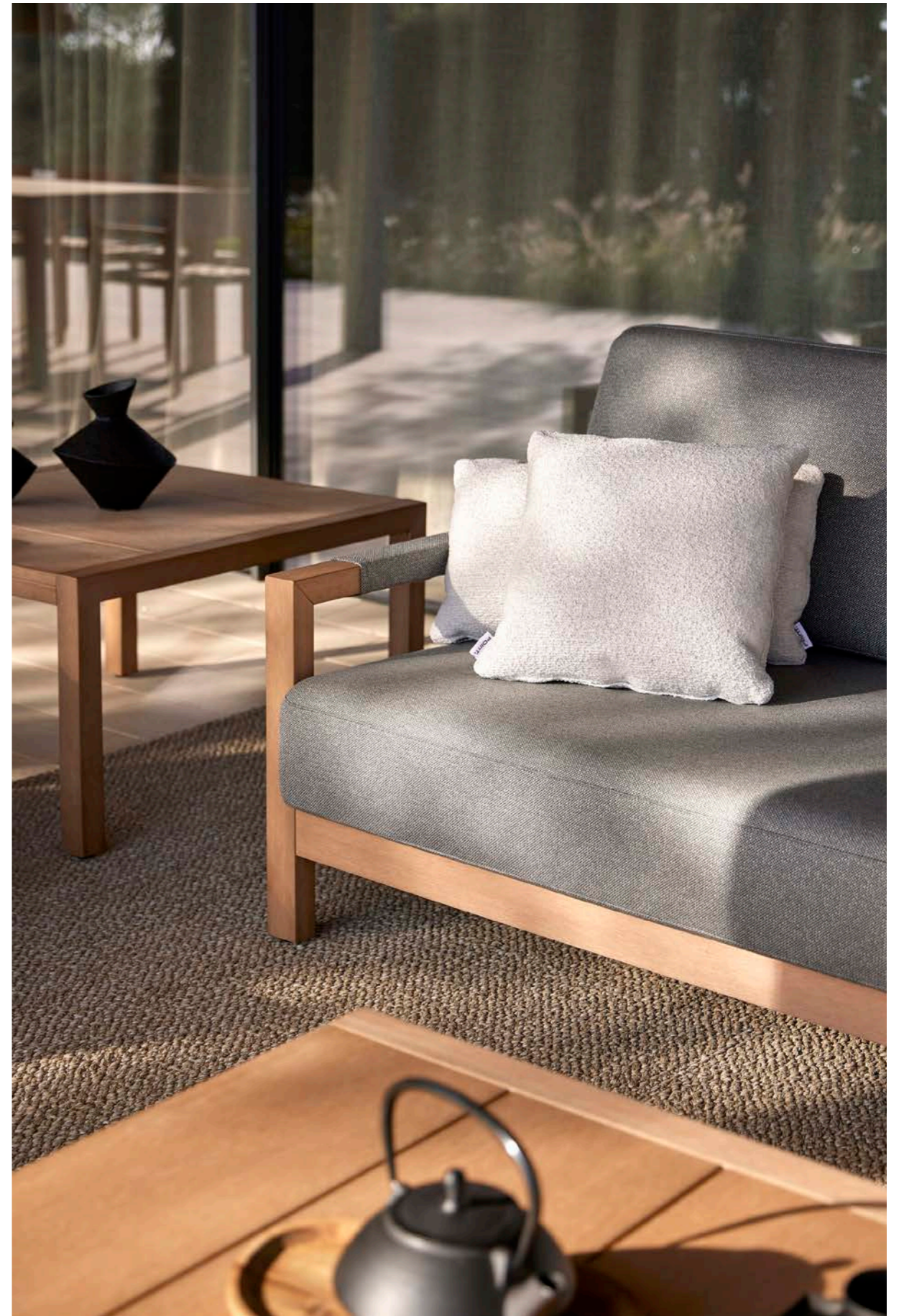



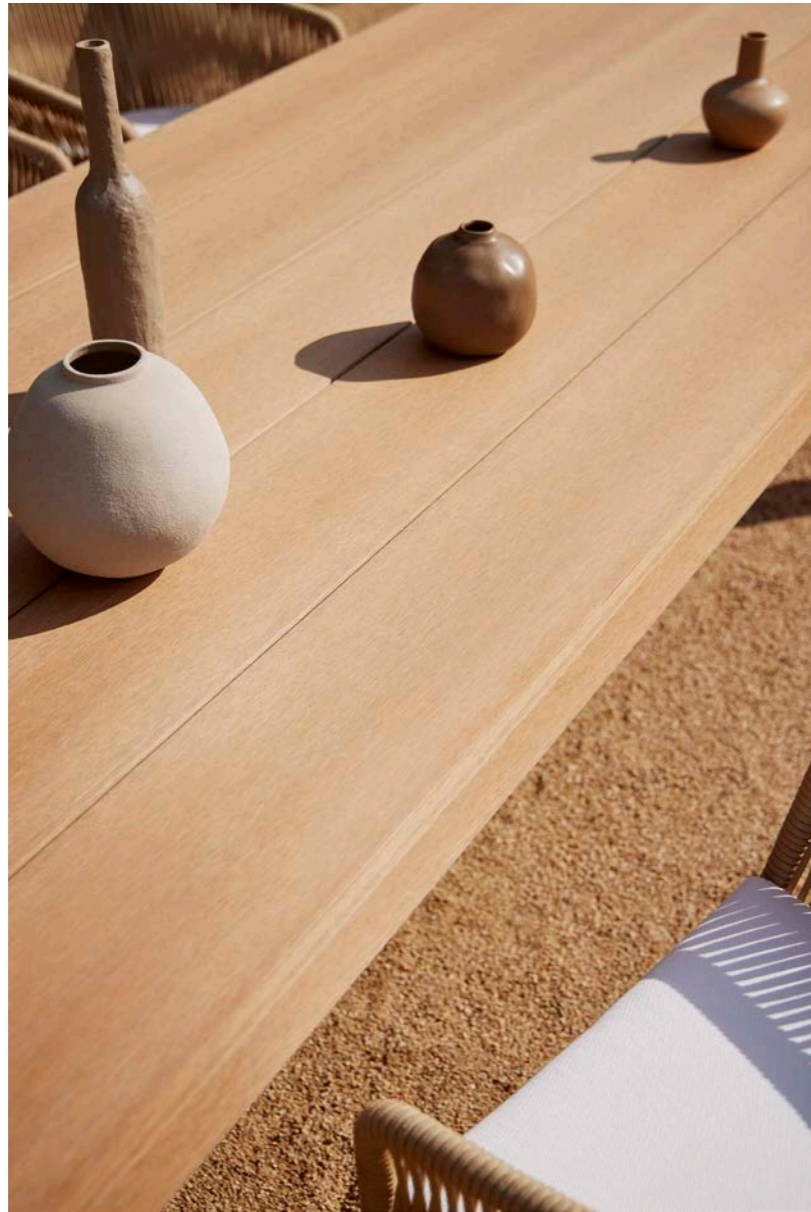



KAHN

POINT STUDIO

MÁXIMO RENDIMIENTO E INNOVACIÓN ECOLÓGICA

La colección rinde homenaje a la arquitectura atemporal y la visión de diseño de Louis Kahn, maestro de las líneas limpias y la simplicidad estructural en la arquitectura. Inspirados por su enfoque en la luz como elemento central en la creación de espacios, hemos diseñado una colección de tumbonas y mesas auxiliares que capturan la esencia del minimalismo y la funcionalidad en su máxima expresión.

En Kahn hemos empleado TechTeak, una nueva teca tecnológica que posee la capacidad de replicar la apariencia cálida y natural de la madera de teca, pero con la ventaja significativa de no requerir mantenimiento. Cada pieza de la colección está diseñada para resistir los rigores de los proyectos contract más exigentes, ofreciendo una solución ideal para entornos que requieren mobiliario resistente y de alta calidad. Además, al final de su ciclo de vida, es 100% reciclable, reafirmando nuestro compromiso con la sostenibilidad.

HIGH-PERFORMANCE & ECOLOGICAL INNOVATION

This collection pays homage to the timeless architectural and design vision of Louis Kahn, the master of clean lines and structural simplicity in architecture. Inspired by his focus on light as a central element in the creation of space, we have designed a collection of loungers and side tables that capture the essence of minimalism and functionality at their finest.

In Kahn, we have used TechTeak, a new technological teak that has the ability to replicate the warm, natural look of teak, but with the significant advantage of being maintenance free. Each piece in the collection is designed to withstand the rigors of the most demanding contract projects, providing an ideal solution for environments that require durable, high-quality furniture. In addition, it is 100% recyclable at the end of its lifecycle, reaffirming our commitment to sustainability.

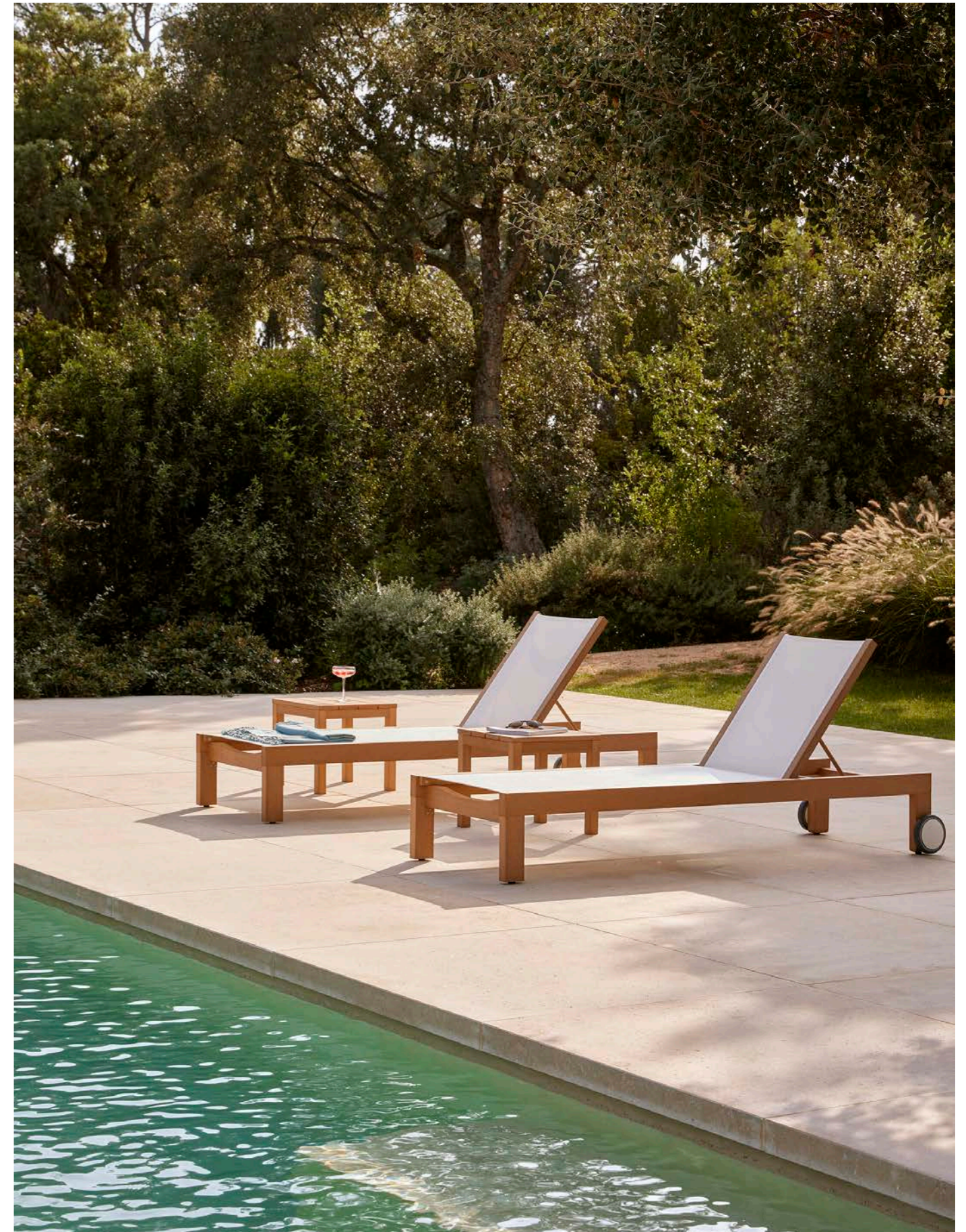



LONG ISLAND

CHRISTOPHE PILLET

UN MODERNO CLÁSICO

«Mi objetivo con Long Island ha sido que fuera tan deseable, con un diseño tan detallista y tan bien terminada como un mueble de interior». Explica el diseñador Christophe Pillet y añade, «busqué crear la sensación de que estas piezas siempre han existido».

Formas rectas y líneas finas definen la silueta de esta colección modular de sofás de exterior. Eminentemente versátil, las piezas que la componen pueden ser un sillón, un sofá o una chaise longue adaptándose a cada espacio. Su diseño, de gran simplicidad, aspira, según confiesa Pillet, «a aportar una elegancia universal y un gran confort». Esta colección persigue convertirse en un nuevo clásico y consta de trece piezas que se complementan con tres mesas con estructura en aluminio.

A MODERN CLASSIC

“My goal with Long Island was to make it as desirable and as well finished as a piece of indoor furniture, with a similarly detailed design”, explains designer Christophe Pillet, adding “I sought to create the feeling that these pieces have always existed”. Straight shapes and slim lines define the silhouette of this modular collection of outdoor sofas. Eminently versatile, the pieces that make up the collection include an armchair, a sofa and a chaise longue, which adapt to fit each space. According to Pillet, its simple design aspires “to offer universal elegance and great comfort”. This collection seeks to become a new classic and consists of thirteen pieces that are complemented by three tables with an aluminum structure.







SUMMER

CHRISTOPHE

PILLET

TRIBUTO A LA TRADICIÓN

El protagonismo de la colección –compuesta por una silla y una butaca con brazos para el comedor– lo toma el trenzado de la cuerda, con el que se ha buscado rendir un homenaje a la artesanía. «Es una manera de que POINT se vuelva a conectar con sus raíces, con su tradición», declara Christophe Pillet. «Estamos ante un objeto casi indefinido, clásico, universal, que rediseñamos muy ligeramente para darle una nueva modernidad». Summer es una revisión de la silla tradicional: universal, simple, funcional y atemporal, ahora vista desde el refinamiento, la precisión técnica y la sensualidad. «El efecto decorativo se produce aquí por la textura del trenzado. Por lo tanto, hay algo muy elaborado (hecho a mano), de diseño muy fuerte y muy simple». Explica el diseñador. Está realizada en aluminio combinado con cuerda y disponible en múltiples colores.

A TRIBUTE TO TRADITION

The main feature of the collection, comprising a dining room chair and armchair, is the woven rope, which is intended as a homage to craftsmanship. “It is a way for POINT to reconnect with its roots, with its tradition”, says Christophe Pillet. “This is an almost indefinite, classic, universal object, which we redesigned very slightly to give it a new touch of modernity”. Summer is a new take on the traditional chair: universal, simple, functional and timeless, but now given a touch of refinement, technical precision and sensuality. “The decorative effect is produced here by the texture of the weave. It therefore has something very elaborate (handmade), with a very strong, very simple design,” explains the designer. It is made from aluminum combined with rope and is available in different colours. The collection also includes three dining tables.







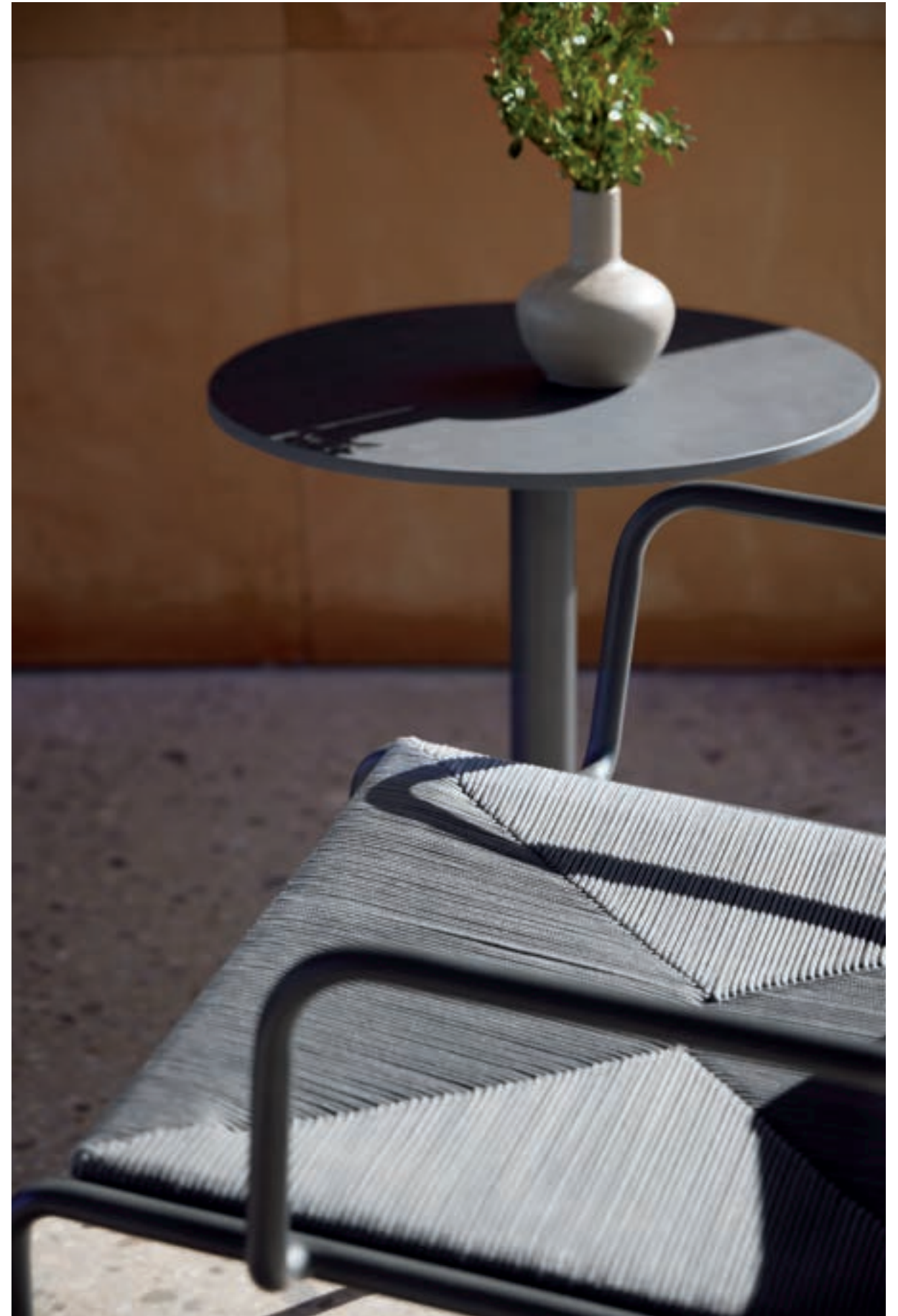



NECK

STUDIO

MENEGHELLO

PAOLELLI

ARTE ESCULTÓRICO, DISEÑO FUNCIONAL

Estrenamos colaboración con el estudio milanés Meneghello Paoelli. Junto al multipremiado dúo de diseñadores hemos creado dos escultóricos pies de mesa bautizados como Neck. “El punto de partida fue la mesa de bistró, que tiene unos límites ergonómicos muy definidos. El desafío fue encontrar un detalle distintivo dentro de estos parámetros”, apuntan Sandro y Marco. Neck es una colección neutra y versátil, pensada para cualquier espacio, especialmente contextos contract y exteriores. “Tenían que ser piezas con medidas estándar y flexibilidad de uso. La personalidad de Neck reside en su base, la cual aporta un toque singular a la pieza, pero de manera discreta y sutil, al ser muy compacta y con un diámetro perfectamente estudiado en términos ergonómicos y visuales”.

En su diseño interactúan tres materiales distintos: la base es de hormigón, su tronco de aluminio pintado en polvo y la superficie puede ser de teca, HPL o porcelánico. “Lo innovador radica en la unión del aluminio y el hormigón, que se produce a media altura, creando una discontinuidad de texturas dentro de una secuencia formal, entre una superficie lisa y colorida, y una porosa y rugosa”, explican. Ambos pies se pueden personalizar en colores -pudiendo escoger entre un blanco mineral o un gris antracita- y en la forma de la superficie -redonda o cuadrada-.

SCULPTURAL ART, FUNCTIONAL DESIGN

In collaboration with the award-winning Milanese studio Meneghello Paoelli, we present two sculptural table legs called Neck. “Our starting point was the bistro table, which has clearly defined ergonomic limits. The challenge was to find a distinctive detail within these parameters”, say Sandro and Marco. Neck is a versatile, neutral collection designed for any space, especially contract and outdoor contexts. “These had to be pieces with standard sizes that offered flexibility of use. Neck’s personality lies in its base, which gives the piece a distinctive touch, but in a discreet and subtle way, as it is very compact with a perfectly studied diameter from an ergonomic and visual point of view”.

Three different materials interact in its design: the base is made from concrete, the body from powder-painted aluminum and the surface can be teak, HPL or porcelain. “Its most innovative feature is the point where the aluminum and concrete meet halfway up the leg, creating a discontinuity of textures within a formal sequence, from a smooth, colored surface to a porous, rough one”, they explain. Both legs can be customized in terms of color -with a choice of mineral white or anthracite gray -and surface shape- round or square.



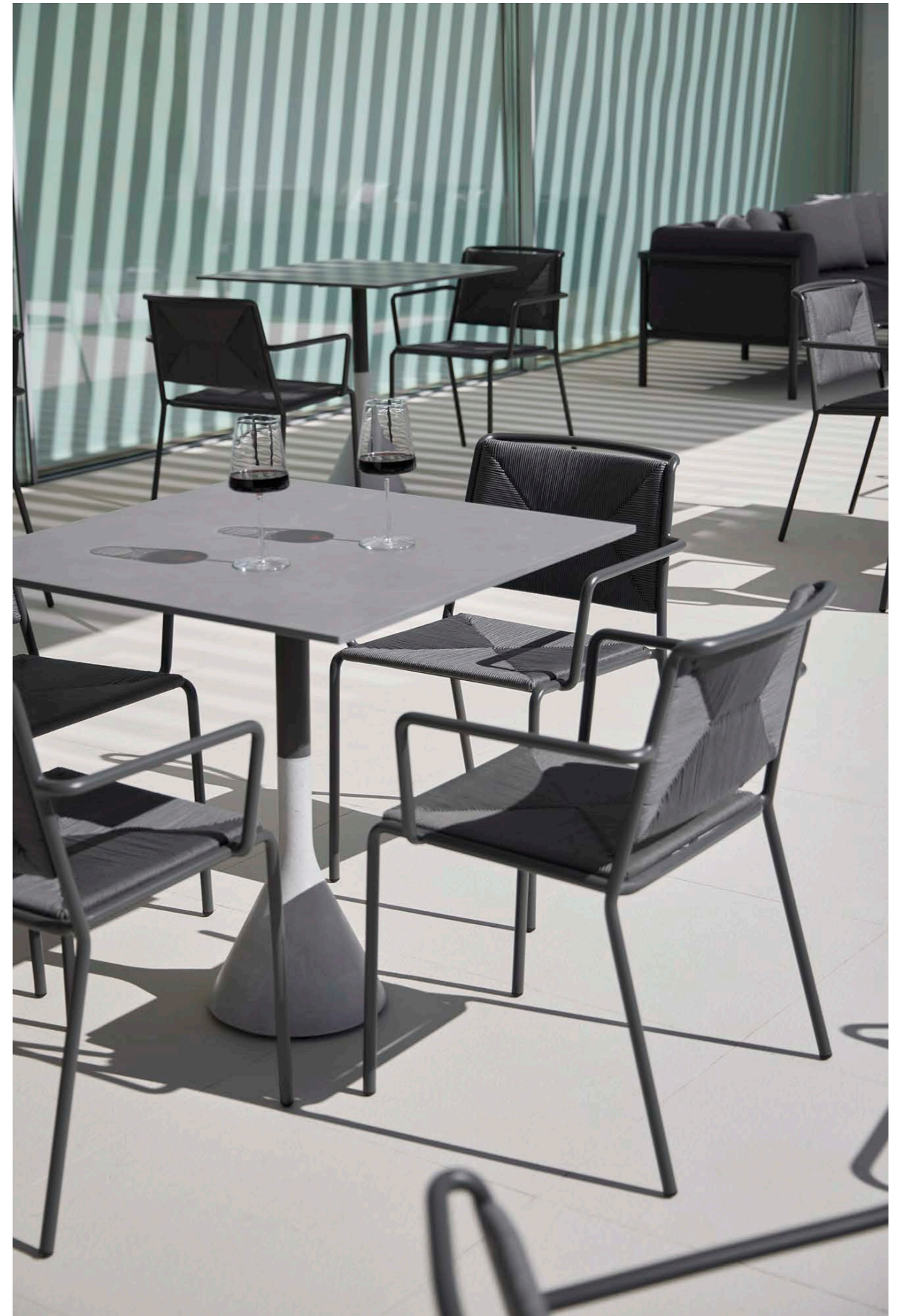





ORIGIN

MARIO RUIZ

EL TRIUNFO DE LA SIMPLICIDAD

“Origin parece una colección sencilla y lo es, es lo que busca su diseño y lo pone en valor porque, pese a lo que pudiera parecer, lo sencillo y lo simple es lo más difícil de diseñar”, afirma Mario Ruiz. El diseñador fiel al “menos es más” que acuñó el arquitecto y uno de los padres de la arquitectura moderna, Mies van der Rohe, demuestra con unos sencillos trazos, que con un discreto gesto se puede llegar muy lejos.

Todas las piezas que conforman la colección son apilables y, además, se adaptan a diferentes composiciones con suma facilidad entre ellas. Las dimensiones son precisas y han sido estudiadas en profundidad para convertirse en aliado versátil tanto para el hogar como para proyectos de contracto de hospitality.

La estructura de todas las piezas es de aluminio pintado en polvo. Este material se escogió por su durabilidad y porque es 100% reciclable al final de su vida útil. La superficie de los asientos y respaldos de sillas o tumbonas es de Batyline y los cojines están tapizados en tejidos de alta resistencia garantizada a la exposición solar. Manteniendo nuestra apuesta por la sostenibilidad, hemos buscado que Origin sea una colección duradera tanto en materiales como en diseño –más allá de tendencias efímeras–, porque sin durabilidad no hay sostenibilidad.

THE TRIUMPH OF SIMPLICITY

“Origin looks like a simple collection, and it is. In fact, that’s the intention behind its design and is its defining feature because, despite what one may think, simple, straightforward pieces are the most difficult thing to design”, says Mario Ruiz. Faithful to the idea of “less is more”, coined by the architect Mies van der Rohe, one of the fathers of modern architecture, the designer demonstrates with a few simple lines that a discreet gesture can go a long way.

All the pieces in the collection can be stacked, and they also fit into different compositions with great ease, creating living, dining and relaxing areas. The dimensions are precise and have been carefully studied to be a versatile ally both for the home and for contract or hospitality projects.

The structure of all the pieces is made from powder-painted aluminum. This material was chosen for its durability and because it is 100% recyclable at the end of its useful life. The surface of the seats and backs of the chairs and loungers is made from Batyline, and the cushions are upholstered in fabrics with guaranteed resistance against sun exposure. In line with our ongoing commitment to sustainability, we have sought to make Origin a long-lasting collection in terms of both materials and design –beyond ephemeral trends– because without durability, there is no sustainability.













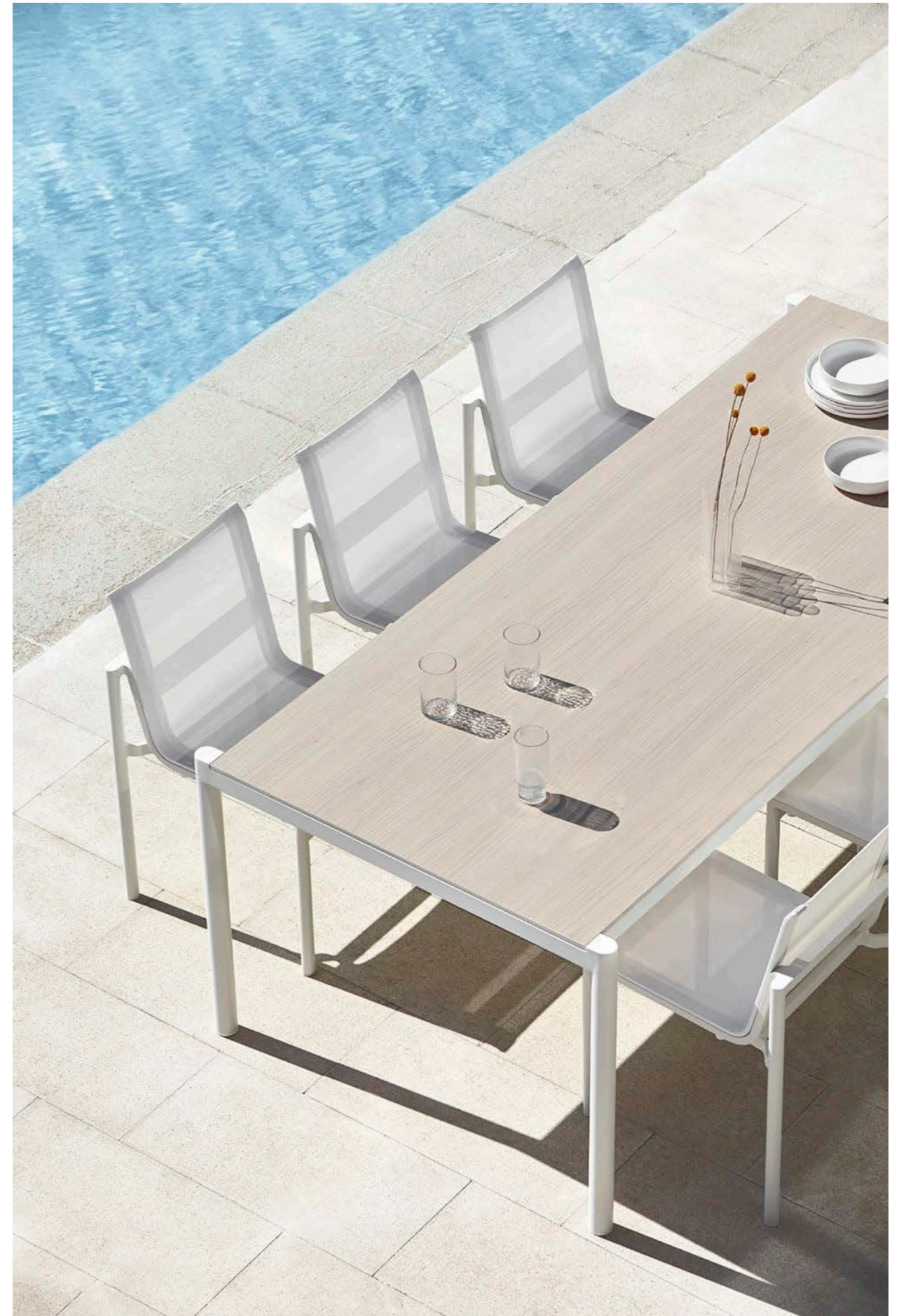

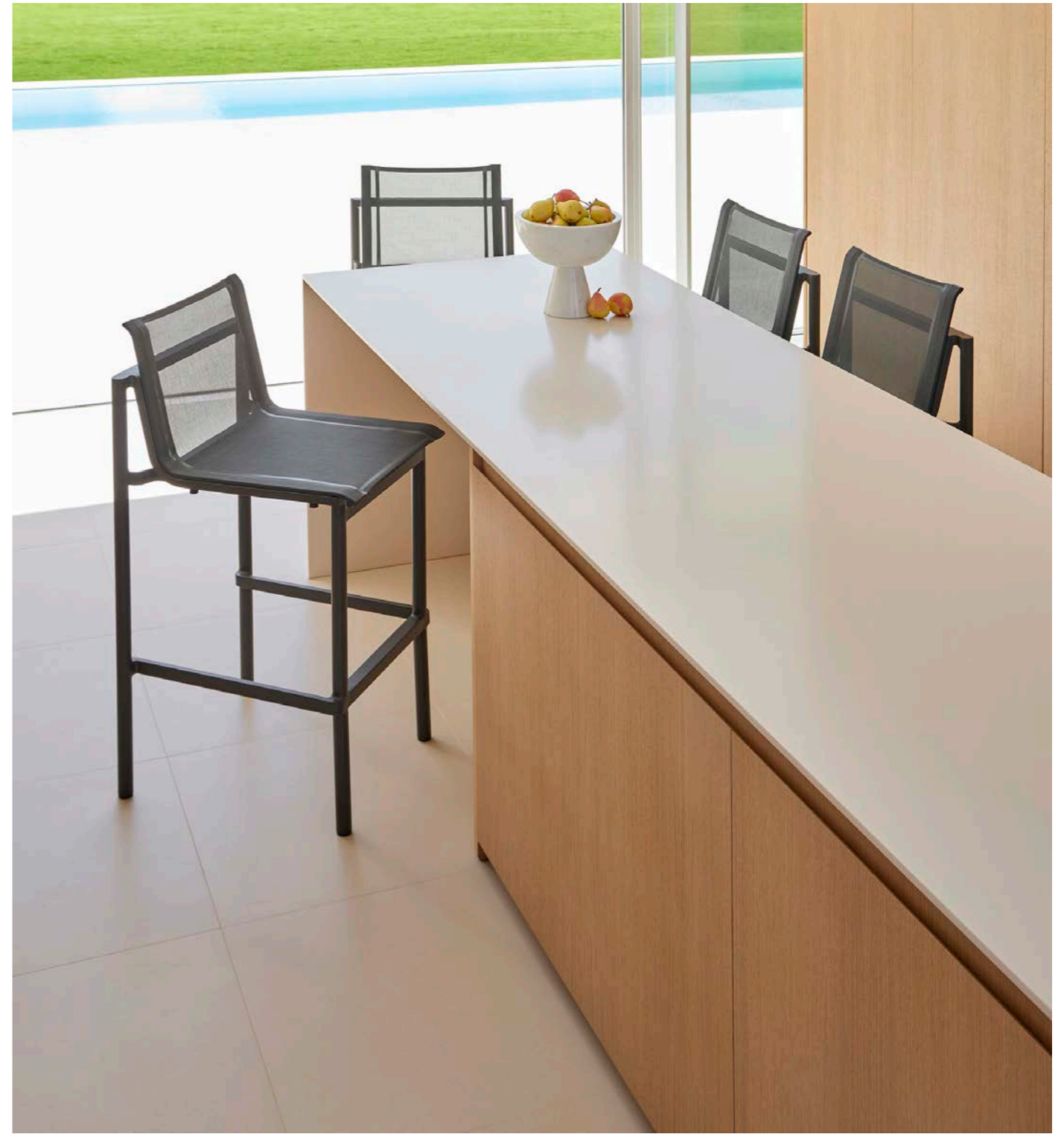

PARALEL

GABRIEL TEIXIDÓ

SERENIDAD ATEMPORAL

Diseñada por Gabriel Teixidó, está llamada a convertirse en un clásico. Como él mismo explica, «su elemento característico, la madera, es un material vivo que conecta bien con las personas y aporta calidez», explica su creador. Robustas y suaves a la vez, sus sillas, sillones, sofás, butacas y mesas combinan la teca de Indonesia (de bosques de tala controlada) y la cuerda sintética. Son un total de catorce piezas a las que se suman una tumbona, una mesita auxiliar y una mesa extensible. Pensadas para jardines, terrazas o porches, se integran con facilidad también en los interiores. «Es una colección humana que encaja perfectamente en ambientes naturales», señala Teixidó.

TIMELESS SERENITY

Designed by Gabriel Teixidó, this collection is set to become a classic. As its creator himself explains, “its characteristic element, wood, is a living element that connects well with people and gives it warmth”. Robust yet soft, its chairs, armchairs, sofas and tables combine Indonesian teak wood (from carefully managed forests) and synthetic rope. There are a total of fourteen pieces, also including a sun lounger, a side table and an extendible table. They are designed for gardens, terraces or porches, integrating easily into indoor spaces too. “It’s a human collection that fits perfectly into natural surroundings”, says Teixidó.









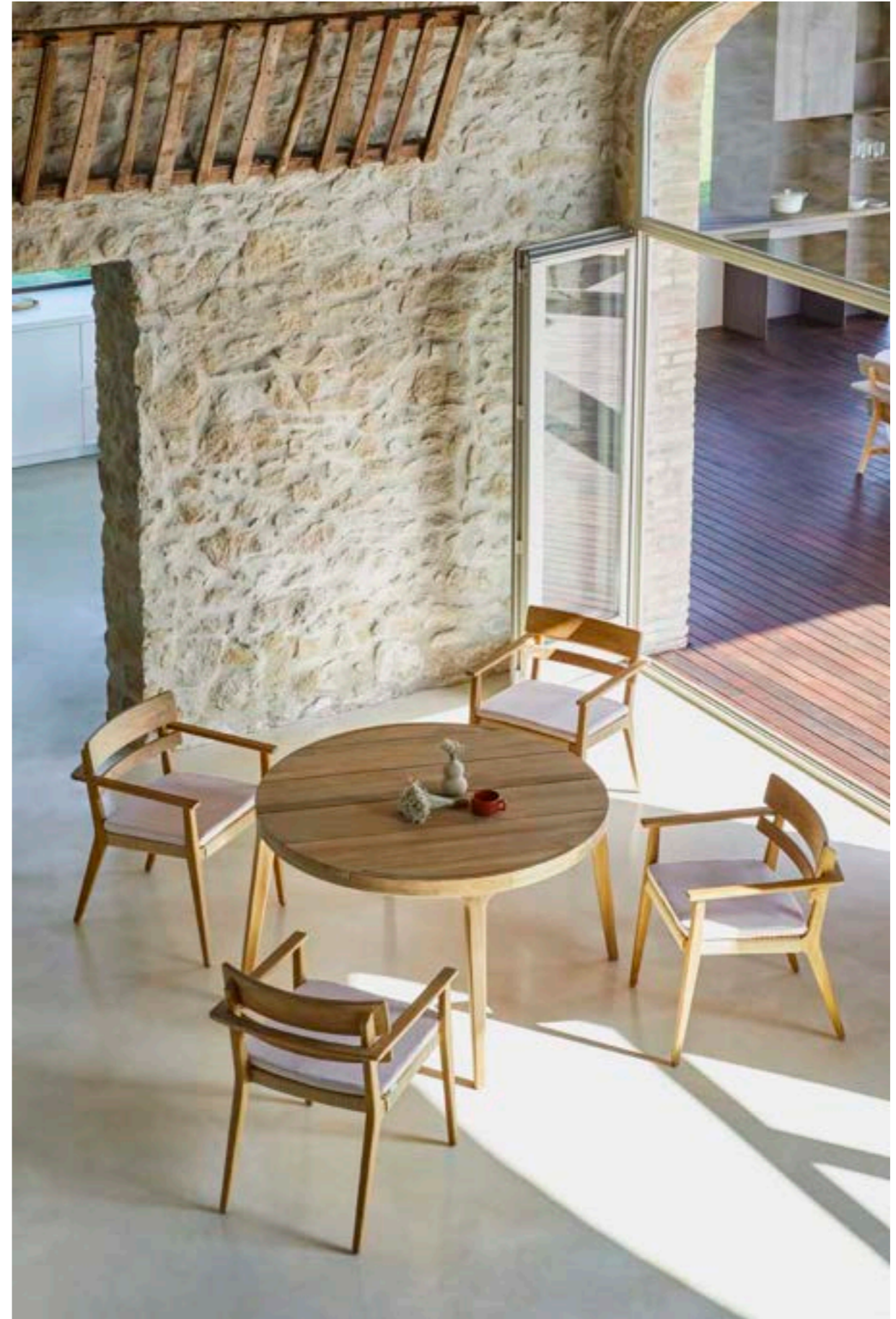

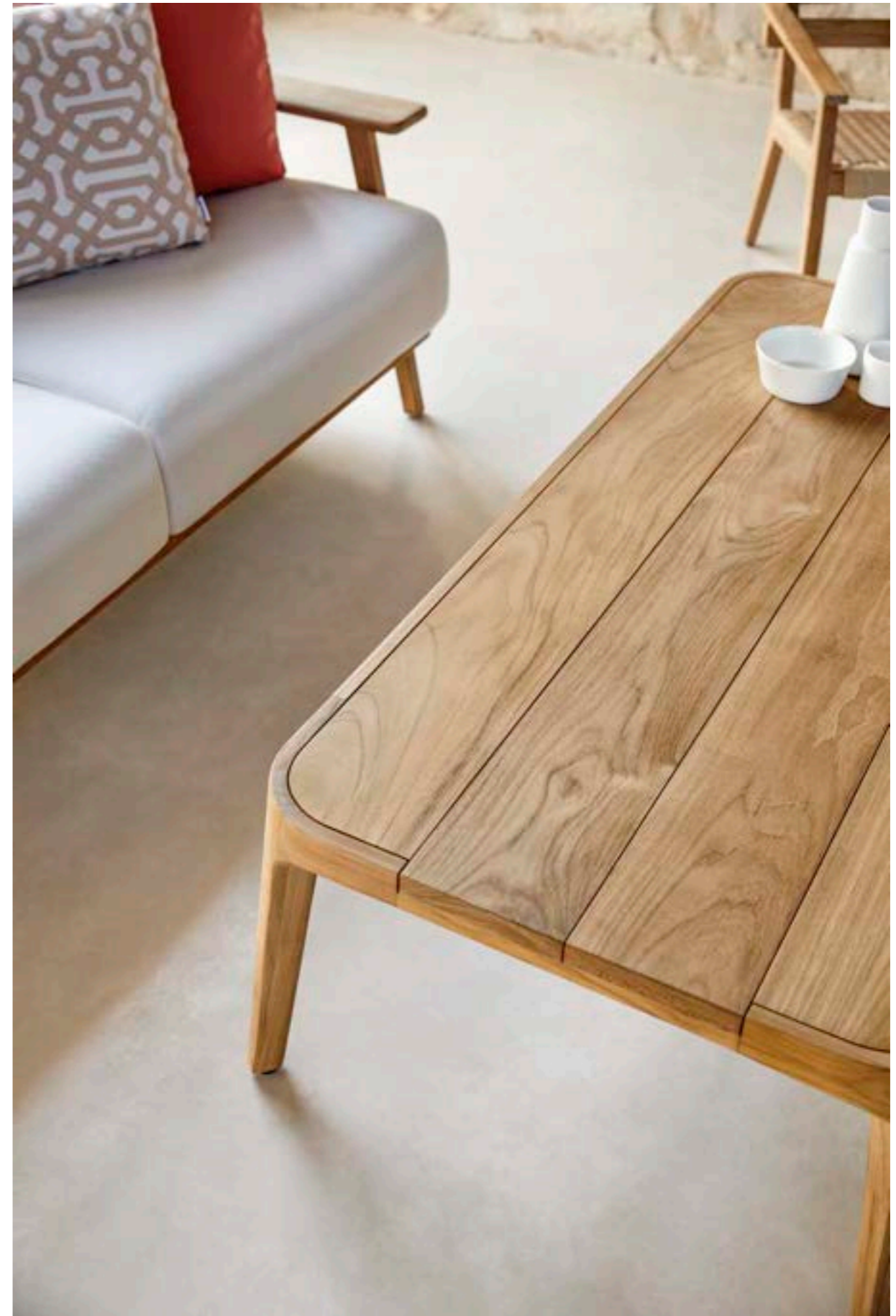



WEAVE

VICENT

MARTÍNEZ

LA COLECCIÓN MÁS PREMIADA DE POINT

Desde que nació en 2017, esta colección de líneas suaves y relajadas, no ha parado de cosechar premios internacionales como el Global Excellence Awards 2018 de la International Interior Design Association, la Medalla de Oro de la Bienal Iberoamericana CIDI de Interiorismo, Diseño y Paisajismo o el Premio ADCV ORO de Mobiliario de Exterior en 2017.

Inspirándose en el anudado de los nidos de los pájaros tejedores baya, Vicent Martínez diseñó esta colección para que fuera tan funcional como emocional. Con un acabado minucioso, cada pieza está creada a mano, anudando fibra a fibra. Consta de un total de veintisiete elementos, desde columpios a mesas, pasando por tumbonas, sofás o sillas, todas ellas con una estructura que envuelve, protege y relaja. Las últimas incorporaciones a la colección han sido un sillón comedor, un pie de mesa redondo en cuerda y una versátil jardinera que también se puede utilizar como puf o mesa. Todas las piezas tienen una estructura de aluminio pintado en polvo y el característico trenzado en cuerda.

Las posibilidades para combinarlas son muy variadas gracias a sus acabados en taupe, banco mineral y negro.

POINT'S MOST AWARD-WINNING COLLECTION

Since it was launched in 2017, this collection with its soft, relaxed lines has reaped many international awards, such as the International Interior Design Association's 2018 Global Excellence Awards, Gold Medal in the Ibero-American Biennial CIDI for Interior, Design and Landscape and the ADCV GOLD Award for Outdoor Furniture in 2017.

Inspired by the way baya weaver birds weave their nests, Vicent Martínez designed this collection to be as functional as it is emotional. Meticulously finished, each piece is created by hand, woven strand by strand. It consists of a total of twenty seven elements, including swings, tables, sun loungers, sofas and chairs, all with a structure that envelops, protects and relaxes. The latest additions to the collection are a dining armchair, a round table base made from rope and a versatile planter that can also be used as a pouffe or table. All the pieces have a powder painted aluminum structure and the characteristic rope weave.

There are a great variety of possible combinations thanks to their finishes in taupe, mineral white and black.





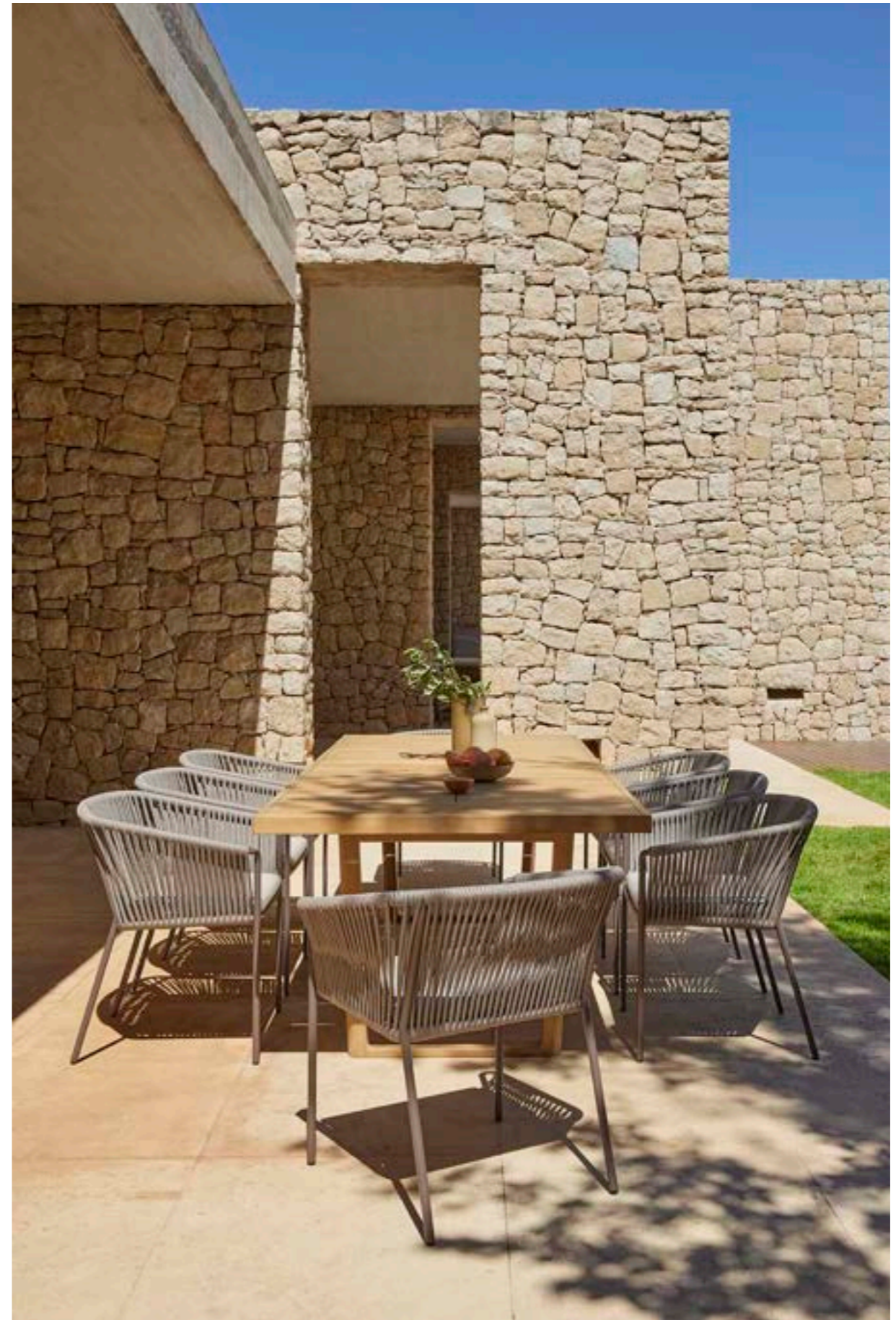
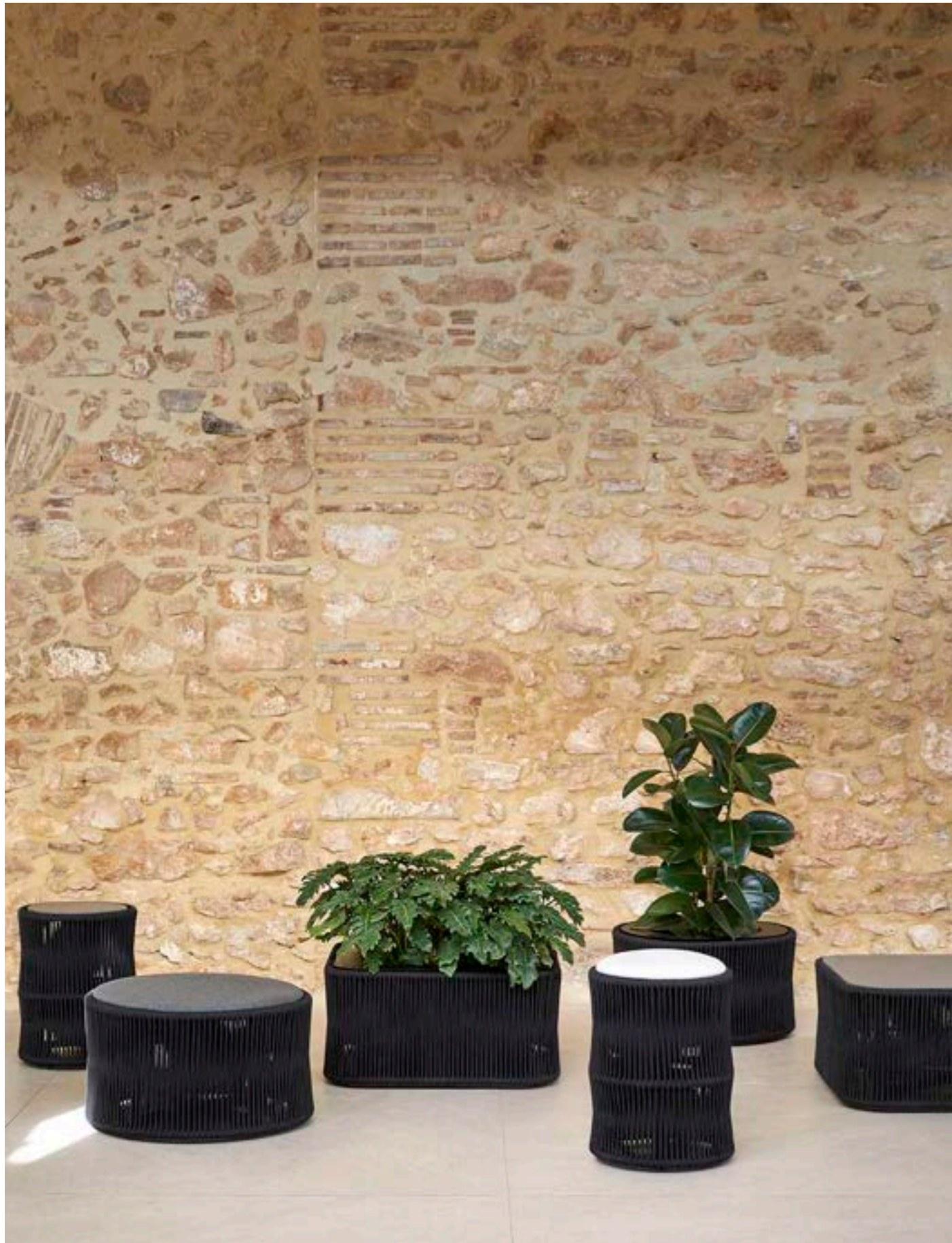













HAMP & ROUND

FRANCESC

RIFÉ

DECLARACIÓN DE INTENCIONES

Para llegar a la estética neominimalista de esta colección, Francesc Rifé trabajó en un proceso de gran complejidad técnica. La madera de teca empleada (procedente de bosques sostenibles de tala controlada) se ha torneado –como si se tratara de un tubo metálico– y se ha doblado, creando una pieza llena de expresividad. Rifé planteó un esqueleto de madera que, mediante un tejido técnico tensado, forma la base y el respaldo sobre el que se apoyan los cojines. El resultado son piezas de dimensiones generosas.

CERRANDO EL CÍRCULO

La inspiración de la colección es la estética minimalista. Round está compuesta por tres mesas, realizadas en madera de teca procedente de bosques sostenibles de tala controlada. Llevan la firma de Francesc Rifé, que ha trabajado con formas sutilmente redondeadas, para llegar a una silueta estilizada y ligera que funciona con sobres de diferentes materiales o modelos.

A STATEMENT OF INTENTIONS

Francesc Rifé developed a technically complex process to achieve the neo-minimalist look of this collection. The teak wood used (sourced from sustainably managed forests) has been turned as if it were a metal tube and bent to create a piece that is full of expressiveness.

Rifé proposed a wooden skeleton with a tensioned technical fabric that forms the base and backrest on which the cushions rest. This has resulted in pieces of generous dimensions.

CLOSING THE CIRCLE

The collection is minimalist aesthetics. Round consists of three tables made from teak wood from sustainably managed forests. It was designed by Francesc Rifé, who has worked with subtly rounded shapes to achieve a light, stylised silhouette that works with different models of tabletop made from different materials.







FUUP

FRANCESC RIFÉ

MENOS ES MÁS

Este conjunto de pufs de Francesc Rifé toma como eje la simplicidad de un círculo, la geometría y el equilibrio. El voluminoso cuerpo tapizado contrasta con una estrecha y resistente base de madera de teca de alta calidad, procedente de bosques sostenibles de tala controlada. Es una pieza funcional y versátil, que se integra en cualquier ambiente, en solitario o combinada con otros elementos. Está disponible en dos tamaños y en múltiples colores y tapicerías.

LESS IS MORE

This set of pouffes by Francesc Rifé revolves around the simplicity of a circle, geometry and balance. The bulk of the upholstered body contrasts with a strong, narrow base made from high-quality teak wood from sustainably managed forests. It is a functional and versatile piece that integrates into any setting, either on its own or combined with other elements. It is available in two sizes and in different colours and upholsteries.



PAL

FRANCESC RIFÉ

DISEÑO QUE LEVITA

«La colección nace como una pieza arquitectónica compuesta por varios módulos que le permiten un sinfín de configuraciones», explica Francesc Rifé, diseñador de la colección. Pal se construye a partir de una base de madera maciza de teca sostenible, procedente de bosques de tala controlada, que funciona como una tarima ligeramente elevada del suelo gracias a unas patas regulables e invisibles. Sobre ella se sitúan los asientos y cojines. «El efecto resultante es el de un sinuoso bloque, casi flotante», añade Rifé. El sistema modular permite componer desde tumbonas hasta sofás o asientos individuales con una amplia variedad de tejidos impermeables y colores. La serie se completa con mesas de centro de diferentes dimensiones también en teca y con una mesa lateral que parte de la base del sofá.

A LEVITATING DESIGN

“The collection is an architectural piece composed of several modules that allow endless configurations”, explains Francesc Rifé, the designer of the collection. Pal is made from a base of solid teak wood from sustainably managed forests that acts as a platform slightly raised off the ground thanks to adjustable, invisible legs. The seats and cushions are placed on top of it. “The resulting effect is that of a sinuous block that almost appears to be floating”, adds Rifé. The modular system makes it possible to construct anything from sun loungers to sofas or individual seats with a wide variety of waterproof fabrics and colours. The series is complemented by coffee tables of different sizes, also in teak, and a side table that arises from the base of the sofa.







HERITAGE

MARIO RUIZ

UN GUIÑO AL ADN DE LA CASA

Mario Ruiz ha partido de un profundo análisis de la historia de POINT y de sus diseños más emblemáticos para desarrollar su primera colección para la firma. En su colección Heritage, toma como referencia el famoso trenzado artesanal de la marca alicantina. También adapta materiales y formatos tradicionales a lenguajes más actuales, fluidos y soft. «Tengo una imagen de los artesanos en los años 20, en Alicante, trabajando el mimbre y creando los primeros muebles de POINT. Aquí nace su alma. Hoy, sigue siendo inspirador», señala el diseñador.

La colección rememora la elaboración y tipologías de las piezas icónicas desde dos propuestas: Heritage Lineal y Heritage Contour, dos diseños que se pueden combinar entre sí. Mientras Heritage Lineal tiene un estilo más conservador, con formas rectas y geometrías equilibradas, el diseño de Heritage Contour apuesta por una silueta más suave y orgánica para construir una figura armoniosa pero más informal. Todas las piezas están fabricadas sobre una estructura de aluminio y tejidas con cuerpo exterior de fibra técnica. Las dos líneas de la colección se expresan en múltiples versiones de sofás, butacas, sillas, taburetes, mesas auxiliares, mesas de comedor, tumbonas y daybeds.

A NOD TO THE COMPANY'S DNA

Mario Ruiz based his first collections on an in-depth analysis of POINT's history and its most emblematic designs. In his Heritage collection, he takes the brand's famous hand weaving as a reference. He also adapts traditional materials and formats to softer, more modern and fluid languages. "I have an image of the artisans in the 1920s in Alicante working with wicker and creating POINT's first furniture. That's where its soul was born. Even today, it's still inspiring," says the designer.

The collection recreates the production and styles of these iconic pieces through two proposals: Heritage Lineal and Heritage Contour, two designs that can be combined with each other. While Heritage Lineal has a more conservative style, with straight shapes and balanced geometries, the design of Heritage Contour adopts a softer and more organic silhouette to create a harmonious but more informal piece. All the pieces are made from an aluminum frame with a woven technical fiber outer body. The two lines of the collection are expressed in multiple versions of sofas, armchairs, chairs, stools, side tables, dining tables, sun loungers and daybeds.













ARC

GABRIEL

TEIXIDÓ

CURVAS SEDUCTORAS

Gabriel Teixidó quiso crear una colección confortable y resistente. Tenía que ser moderna pero con un carácter neutro que le permitiese adaptarse en cualquier entorno. Apostó por emplear el trenzado tradicional en fibra reciclable Shintotex –desarrollada por POINT– para crear los asientos y respaldos, que combinó con patas en madera de teca procedente de bosques sostenibles de tala controlada y un cojín en espuma de poliuretano, preparado para soportar la intemperie. Así consiguió llegar a una colección contemporánea con detalles clásicos.

SEDUCTIVE CURVES

Gabriel Teixidó wanted to create a comfortable yet hard-wearing collection. It had to be modern but with a neutral character that would allow it to fit into any environment. He chose to use a traditional weave in the recyclable Shintotex fiber, developed by POINT, to create the seats and backrests, which he combined with legs made of teak wood from sustainably managed forests and a polyurethane foam cushion that is made to withstand the elements. He has managed to achieve a contemporary collection with classic details.

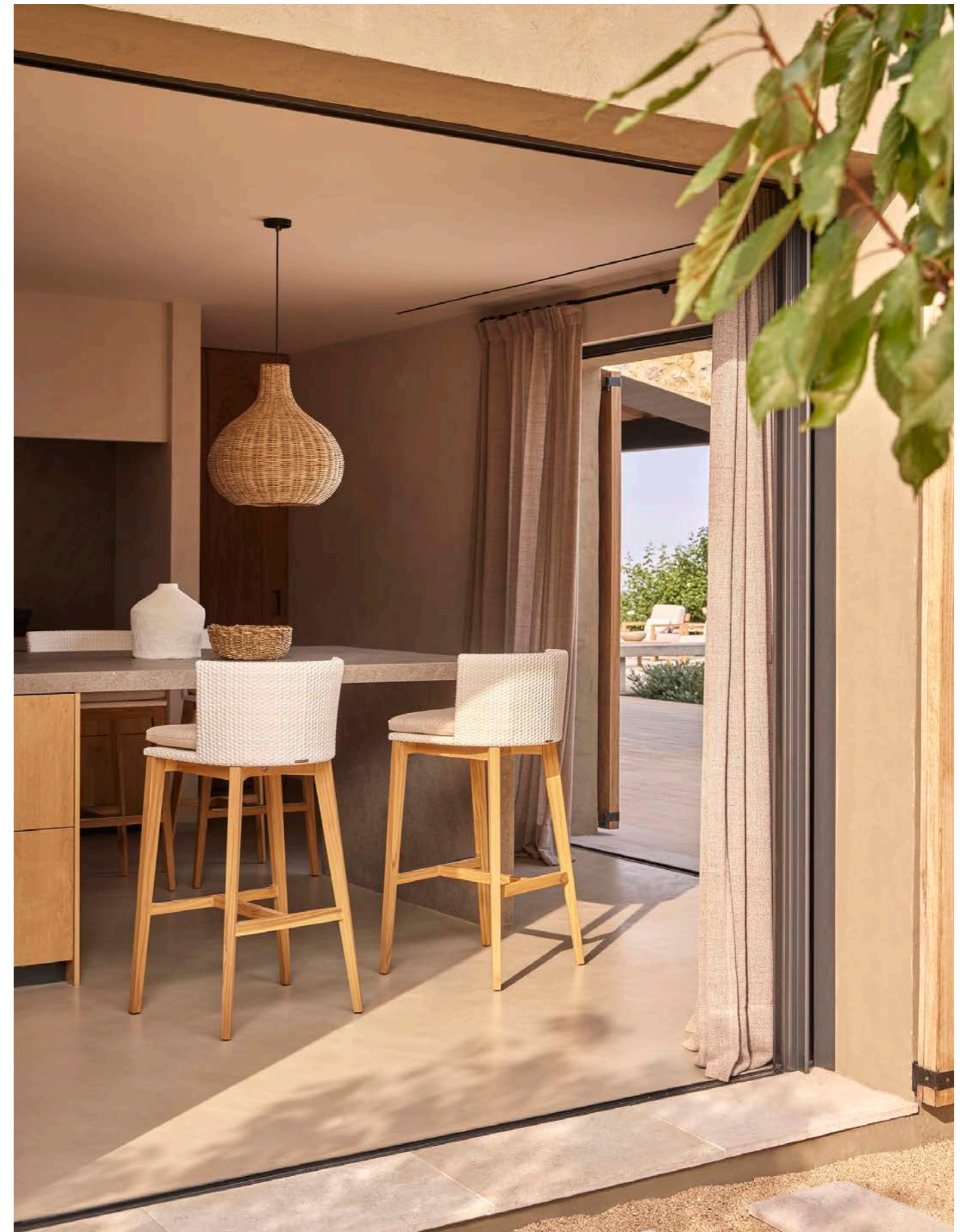



LIS

POINT STUDIO

LA VERSATILIDAD EN PIE

Un elemento que combina, sin estridencias, con diferentes colecciones, materiales y estilos. La clave de estos dos pies de mesa, desarrollados por POINT Studio, ha sido partir de un diseño, en apariencia sencillo, que encierra la filosofía de POINT. Son piezas versátiles cuyas formas simples se integran perfectamente en cualquier entorno, ayudando a conseguir ambientes contemporáneos y elegantes.

A nivel técnico, se ha trabajado en desarrollar las bases con un diámetro exacto que asegure una gran estabilidad a la mesa.

A VERSATILE BASE

An element that can be combined with different collections, materials and styles without any fuss.

The key to these two table bases, developed by POINT Studio, is that they are based on an apparently simple design that embodies POINT's philosophy. They are versatile pieces whose simple shapes integrate perfectly into any environment, helping to achieve a stylish, contemporary setting.

Technically, we have worked on developing the bases so that they have an exact diameter that gives the table great stability.



KHAI

POINT STUDIO

UN VIAJE SENSORIAL AL MAR EGEO

El equipo de POINT Studio quiso crear una pieza con un fuerte carácter mediterráneo. Con una forma escultórica, la precisión en el trenzado de la cuerda –especialmente en la curvatura del brazo– y la perfección de su acabado artesanal, otorgan a Khai una gran personalidad. Este entramado de cuerda, disponible en tonos turrón, taupe y negro, se combina con elementos en madera de teca (procedente de bosques sostenibles de tala controlada).

A SENSORY JOURNEY TO THE AEGEAN SEA

The POINT Studio team wanted to create a piece with a strong Mediterranean flavour. With its sculptural shape, the precision of its rope weave, especially in the curve of the arm, and the perfection of its hand-crafted finish, Khai has plenty of personality. This rope weave, available in a nougat colour, taupe and black, is combined with teak wood elements (sourced from sustainably managed forests).





BAY

POINT STUDIO

ARQUITECTURA HECHA MUEBLE

En un primer vistazo, cautivan sus líneas rectas, la precisión de sus formas arquitectónicas. Y, después, el tacto. La madera de teca (procedente de bosques sostenibles de tala controlada), introduce un material natural que invita a tocar, a acariciar. Bay está compuesta por una tumbona y una mesita auxiliar, desarrolladas por POINT Studio. Se inspiran en el ambiente de una bahía, capturando el espíritu marinero de un club náutico y reinterpretándolo para llevarlo a terrazas y jardines. Bay está pensada para combinarse con otras piezas y se adapta en cualquier entorno –clásico o contemporáneo–.

ARCHITECTURE AS FURNITURE

At first glance, its straight lines and the precision of its architectural forms are captivating. As well as the feel of it. Teak wood (from sustainably managed forests) gives it a natural component that begs to be touched, caressed. Bay consists of a sun lounger and a side table developed by POINT Studio. They are inspired by the atmosphere of a bay, capturing the seafaring spirit of a yacht club and reinterpreting it for terraces and gardens. Bay is designed to be combined with other pieces and adapts to any environment, classic or contemporary.





COLORS

GABRIEL

TEIXIDÓ

EMPEZAR CON BUEN PIE

El detalle que le aporta la personalidad, es también el que garantiza su estabilidad y resistencia: dos aspas simétricas que se unen en forma de cruz en la base. Los pies de mesa Colors están pensados para combinarse con las diferentes tapas disponibles en el catálogo de POINT. Están hechos en aluminio pintado en polvo de alta resistencia a la intemperie y se presentan en una amplia variedad de colores que va desde los tonos blancos o tostados, al azul cielo, pasando por el terracota, gris, óxido o arena. Su silueta minimalista lo hace único para integrarse sin problema en cualquier ambiente.

START FROM A GOOD BASE

The detail that gives it its personality is also what guarantees its stability and strength: two symmetrical blades that meet in the form of a cross at the base. Colors table bases are designed to be combined with the different tabletops available in POINT's catalogue. They are made from powder coated aluminum, which is highly resistant to weathering and available in a wide variety of colours, ranging from white and toasted to sky blue, terracotta, grey, rust and sand. Its minimalist silhouette makes it unique and easy to integrate into any setting.



SUNSET

ESTHER

CAMPOS

VISTO Y NO VISTO

La búsqueda de la privacidad fue la consigna que guió a Esther Campos a la hora de diseñar esta tumbona con dosel. Su estructura, en aluminio anodizado resistente a la corrosión, incorpora una base trenzada en Shintotex, una fibra reciclable de alta resistencia desarrollada por POINT. En el interior, la doble tumbona es reclinable. El exterior se envuelve con unas cortinas de Sunbrella –un tejido técnico resistente a los rayos UVA, los hongos, las manchas y a los procesos de limpieza–. «Las cortinas permiten crear momentos íntimos al aire libre, además hacen que la pieza se adapte estéticamente a cualquier ambiente», explica Campos. «Es un elemento que evoca cierto romanticismo». El techo de Sunset se produce en lona screen, un tejido con microporos que permite la entrada del aire pero mantiene el calor en el exterior.

IN AN INSTANT

The search for privacy was what guided Esther Campos when it came to designing this canopied sun lounger. Its corrosion-resistant anodised aluminum structure includes a woven base made from Shintotex, a highly resistant recyclable fiber developed by POINT. On the inside, the double sun lounger is reclining. The outside is enveloped by Sunbrella curtains, a technical fabric that is resistant to UV rays, fungus, stains and cleaning processes. “The curtains allow us to create intimate moments in the open air, as well as meaning that, aesthetically, the piece fits into any setting,” explains Campos. “It is an element that evokes a certain romanticism”. The ceiling of Sunset is formed by screen canvas, a fabric with micropores that allows air in but keeps the heat out.

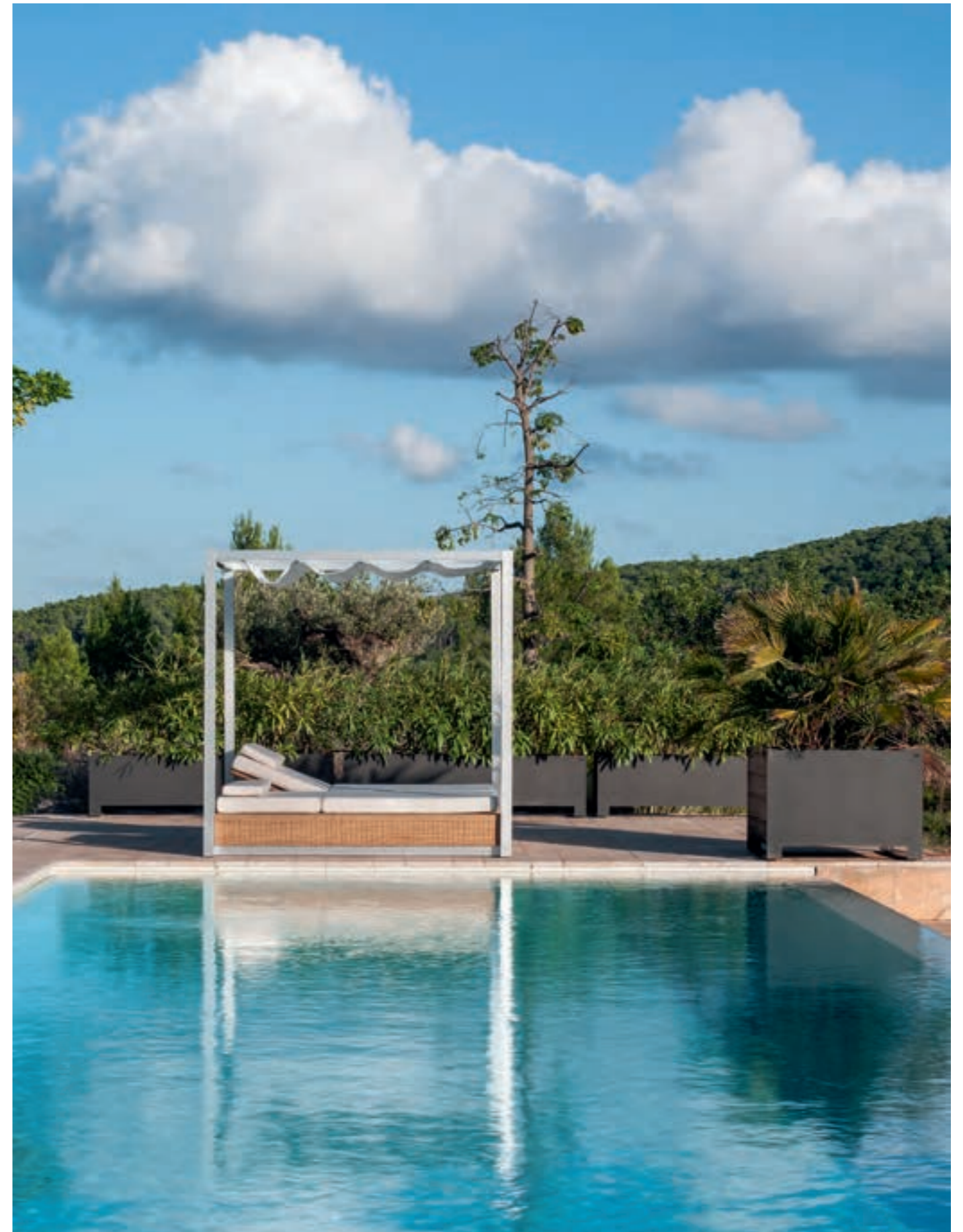



Classic

ALGA
CHARLESTON
SAGRA
CADDIE
HAVANA
ARENA
BREDA
BRUMAS
ROMANTIC

ALGA

ALFONSO

GALLEGO

EL ORIGEN DE TODO

José Pons Pedro, el fundador de POINT, incorporó este modelo de sillón en las primeras colecciones (años 20). Él le aportó su toque personal de diseño y de calidad. Apostó por darle mucha rigidez en las revueltas de los brazos, de manera que no se rompieran con el paso del tiempo. También incorporó los calados del respaldo, que lo hacían menos pesado a la vista.

La dificultad de esta pieza está en que se teje toda al aire. No tiene estructura desde el asiento hacia arriba. El soporte de los brazos y de la parte superior del respaldo es el tejido que sube desde el asiento.

La rigidez de las revueltas de los brazos termina por darle solidez. No la pueden elaborar todos los artesanos. Requiere manos muy expertas.

Se ha hecho en muchos materiales: mimbre, médula de ratán (en esta fibra durante más de 70 años) y posteriormente en Shintotex –una fibra reciclable de alta resistencia desarrollada por POINT– con estructura de aluminio. Esta última es la versión que continúa hoy en día en producción. La última adaptación la dirigió el diseñador Alfonso Gallego. Tenía el reto de actualizar el modelo y convertirlo en un elemento que fuera más allá del tiempo, las modas y las tendencias. Gallego define el sillón Alga como «una pieza de estilo romántico mediterráneo con identidad propia».

THE ORIGIN OF IT ALL

José Pons Pedro, the founder of POINT, included this model of armchair in the first collections (in the 1920s). He gave it his personal touch of design and quality. He chose to make the armrests very rigid so that they would not break with the passage of time. He also included the openwork of the backrest, which made it less heavy on the eye.

The difficulty with this piece is that it is woven entirely in the air. It has no structure from the seat upwards. The arms and back are a continuation of the seat. The rigidity of the armrests gives it its ultimate touch of solidity. It cannot be made by just any craftsman; it requires highly expert hands.

It has been made with many materials: wicker, rattan core (with this fiber for more than 70 years) and later with Shintotex, a highly resistant recyclable fiber developed by POINT, with an aluminum structure, which is the version still in production today.

The latest adaptation was led by designer Alfonso Gallego. He had the challenge of updating the model and turning it into an element that would go beyond time, fashions and trends. Gallego defines the Alga armchair as “a piece in the romantic Mediterranean style with its own identity”. This collection also has two round dining tables.





CHARLESTON

ALFONSO

GALLEGO

CON SWING

El glamour de los cruceros de los felices años 20 del pasado siglo inspira esta pieza diseñada por Alfonso Gallego. «El mayor reto para crear esta colección atrevida y elegante fue adaptar las estructuras y el tejido a la fibra con la que se reviste la pieza», explica el diseñador. El trenzado en Shintotex –una fibra reciclable de alta resistencia desarrollada por POINT– crea un estampado con movimiento con el que se recubre la estructura en aluminio. Charleston está disponible en color tostado.

SWINGING

This piece designed by Alfonso Gallego was inspired by the glamour of the cruise ships of the Roaring Twenties. “The biggest challenge in creating this bold, elegant collection was to adapt the structures and fabric to the fiber with which the piece is covered”, explains the designer. It is woven in Shintotex, a highly resistant recyclable fiber developed by POINT, creating a pattern with movement that covers the aluminum structure. Charleston is available in a toasted colour.





SAGRA

ALFONSO

GALLEGO

PIEZA GANADORA

El sillón Sagra presume de una silueta clásica que se revisita simplificando su contorno con líneas sencillas. Un cuidado estudio de la proporción ha conseguido integrar la técnica del trenzado artesanal en ambientes contemporáneos en los que su estética convive perfectamente. Este sillón es un comodín para distintos estilos: se acopla bien al rústico chic y al estilo dolce vita, pero también es un gran jugador en los interiores.

A WINNING PIECE

The Sagra armchair boasts a classic silhouette that is revisited with its simple lines. A careful study of proportion has succeeded in perfectly integrating the look of its hand-woven technique into contemporary settings. This armchair is a wild card for different styles: it fits in well with a rustic chic or dolce vita style, but it is also great for interiors.



CADDIE

ALFONSO

GALLEGO

EL MEJOR APOYO

El diseño se pone al servicio del espacio con el sillón Caddie firmado por Alfonso Gallego. «El punto de partida fue buscar un nuevo concepto de sillón que se convirtiera en un nuevo clásico moderno», explica. El resultado es una pieza contemporánea y equilibrada en la que se logra conjugar lo simple y lo funcional. Los sillones son apilables y están fabricados en estructura de aluminio lacada, con un trenzado en fibra Shintotex, una fibra reciclable desarrollada por POINT. Está disponible en dos acabados: tostado y marfil. Todos ellos se integran fácilmente en cualquier ambiente contemporáneo.

THE BEST SUPPORT

Design works with space in the Caddie armchair designed by Alfonso Gallego. “The premise was to look for a new concept of armchair that would become a new modern classic”, he explains. The result is a balanced, contemporary piece that manages to combine simplicity and functionality. The armchairs are stackable and are made from a lacquered aluminum structure, woven with Shintotex fiber, a recyclable fiber developed by POINT. It is available in two finishes: toasted and ivory, all of which can be easily integrated into any contemporary setting.



HAVANA

ALFONSO

GALLEGO

CUESTIÓN DE MaticES

«El Caribe, las calles de Cuba, las tardes de ron, el relax y la calidez fueron la inspiración», explica Alfonso Gallego, diseñador del sillón de comedor Havana. El contraste es la clave de esta pieza fabricada con una estructura de aluminio lacado, recubierto con un trenzado en Shintotex –una fibra reciclable de alta resistencia desarrollada por POINT–. Las formas sinuosas de esta pieza están pensadas para acoger y, como en las mejores fotos, el blanco y negro toma protagonismo en el trenzado creando dibujos llenos de ritmo.

A MATTER OF NUANCES

“The Caribbean, the streets of Cuba, afternoons drinking rum, relaxation and warmth were the inspiration”, explains Alfonso Gallego, the designer of the Havana dining armchair. Contrast is the key to this piece made from a lacquered aluminum structure covered with woven Shintotex, a highly resistant recyclable fiber developed by POINT. The sinuous shapes of this piece are designed to fold around us and, as in the best photos, black and white takes centre stage in the weave, creating patterns that are full of rhythm.





ARENA

ALFONSO GALLEGO

ADN MEDITERRÁNEO

Esta colección se inspira en recuerdos del pasado y en los veranos mediterráneos. Alfonso Gallego parte de ellos para marcar «el inicio de una nueva etapa», según explica. Arena es una colección que busca el confort y el desenfado, con una estética clásica que rememora las siluetas de los años sesenta. Emplea el trenzado tradicional de POINT con su fibra reciclable Shintotex sobre una estructura en aluminio y los cojines están realizados en una resistente espuma de poliuretano.

La colección se compone de sillón tresillo, sofás, mesa de centro, rinconera y un puf. Está disponible en color tostado.

MEDITERRANEAN ESSENCE

This collection is inspired by memories of the past and Mediterranean summers. Alfonso Gallego takes them as a starting point to mark “the beginning of a new stage”, as he explains. Arena is a collection that seeks to be comfortable and casual, with a classic look reminiscent of the silhouettes of the sixties. It uses POINT’s traditional weave with its recyclable Shintotex fiber on an aluminum structure and the cushions are made from strong polyurethane foam. The collection is composed of an armchair, three-seater and two-seater sofas, coffee table, corner unit and a pouffe. It is available in a toasted colour.





BREDA

ALFONSO

GALLEGO

NUEVOS MITOS

Compuesta por una tumbona reclinable y una mesa auxiliar, la principal característica de esta colección son sus líneas ligeramente redondeadas y un trenzado especial que crea una peculiar trama con la fibra Shintotex –una fibra reciclable desarrollada por POINT–. Para facilitar el movimiento, la tumbona incorpora ruedas. Esta colección tiene reminiscencias estéticas que evocan el diseño nórdico, pasado por un tamiz mediterráneo.

NEW MYTHS

Consisting of a reclining lounger and a side table, the main feature of this collection is its slightly rounded lines and a special weave that creates a peculiar, intertwined texture with Shintotex, a recyclable fiber developed by POINT. The lounger has wheels to make it easy to move around. The aesthetic of this collection is reminiscent of Nordic design, seen through a Mediterranean filter.



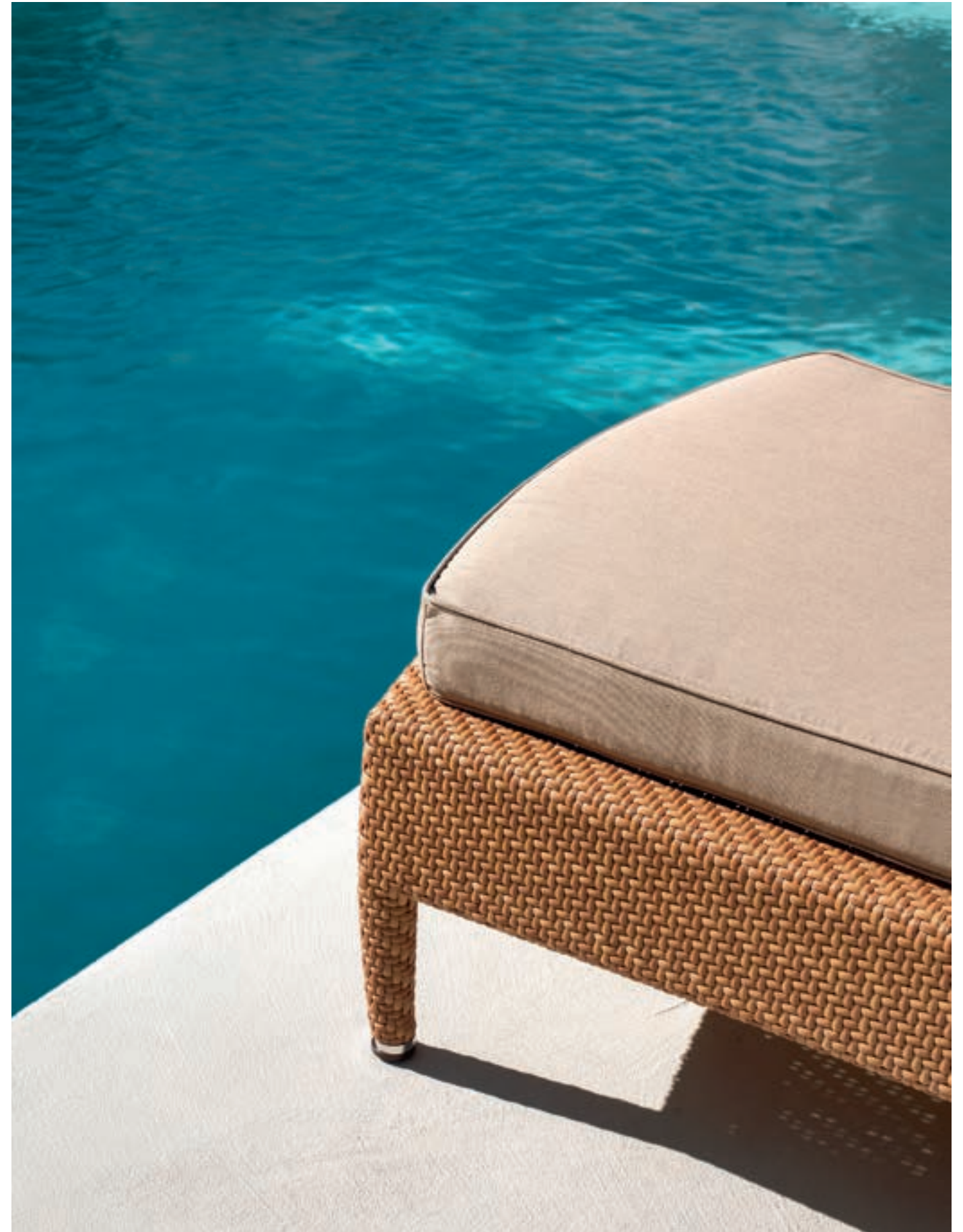

BRUMAS

ALFONSO

GALLEGO

PURO ROMANTICISMO

La inspiración nace de los muebles coloniales de exterior. Con esta base, Alfonso Gallego firma una colección que se caracteriza por su «identidad única y una gran presencia», tal como explica. Brumas reinterpreta estilos clásicos y los refresca haciéndolos más actuales y adaptables a diferentes ambientes. Las piezas se realizan a partir de una estructura de aluminio que se recubre con un trenzado tradicional artesanal en fibra Shintotex –una fibra reciclable desarrollada por POINT–, que lo hace resistente a la intemperie y duradero. La colección se compone de un sillón, sofás de dos y tres plazas.

PURE ROMANTICISM

The inspiration comes from colonial outdoor furniture. On this basis, Alfonso Gallego has created a collection characterised by its “unique identity and great presence”, as he explains. Brumas reinterprets and updates classic styles, modernising them and making them more adaptable to different settings. The pieces are made from an aluminum structure covered with a traditional weave in Shintotex fiber, a recyclable fiber developed by POINT, which makes it weather resistant and hard wearing. The collection is composed of an lounge chair, two-seater and three-seater sofas.





ROMANTIC

POINT STUDIO

LA REINA DEL JARDÍN

La suave curvatura de esta tumbona redonda ha sido pensada por el equipo de POINT Studio para ser protagonista en espacios amplios. Con o sin capota, puede ser un refugio para protegerse del sol o, simplemente, una gran tumbona sobre la que descansar. Su estructura está realizada en aluminio lacado, con un acabado especial para resistir las inclemencias del tiempo y recubierta con un trenzado en Shintotex –una fibra reciclable de alta resistencia desarrollada por POINT– y patas en aluminio anodizado.

THE QUEEN OF THE GARDEN

The soft curve of this round sun lounger has been designed by the POINT Studio team to take centre stage in large spaces. With or without a canopy, it can be a shelter from the sun or simply a large lounger on which to rest. Its structure is made from lacquered aluminum, with a special finish to resist adverse weather conditions and covered with woven Shintotex, a highly resistant recyclable fiber developed by POINT, and legs in anodised aluminum.





Tops

TOPS

PARA TODO, PARA TODOS

Redondas, cuadradas, familiares, auxiliares...
Esta colección es sinónimo de versatilidad.
Para adaptarse a cualquier espacio –exterior o interior–, Tops reúne tapas de mesa de diferentes materiales (madera de teca, HPL o porcelánico), formas y tamaños (desde 50 a 130 cm de diámetro las redondas, desde 70x70 cm las cuadradas y, de 160x90 las rectangulares). Hay versiones para todos los gustos y ambientes y todas son combinables con diferentes pies disponibles en las colecciones de POINT.

FOR EVERYTHING, FOR EVERYONE

Round, square, family-sized, for side tables...
This collection is versatility itself. Tops offers tabletops made from different materials (teak wood, HPL and porcelain) in different shapes and sizes (50 to 130 cm diameter round ones, square ones measuring 70x70 cm and larger, and rectangular ones from 160x90 cm) to fit any space, outdoor or indoor. There are versions to suit all tastes and atmospheres and they can all be combined with the different legs available in POINT's collections.

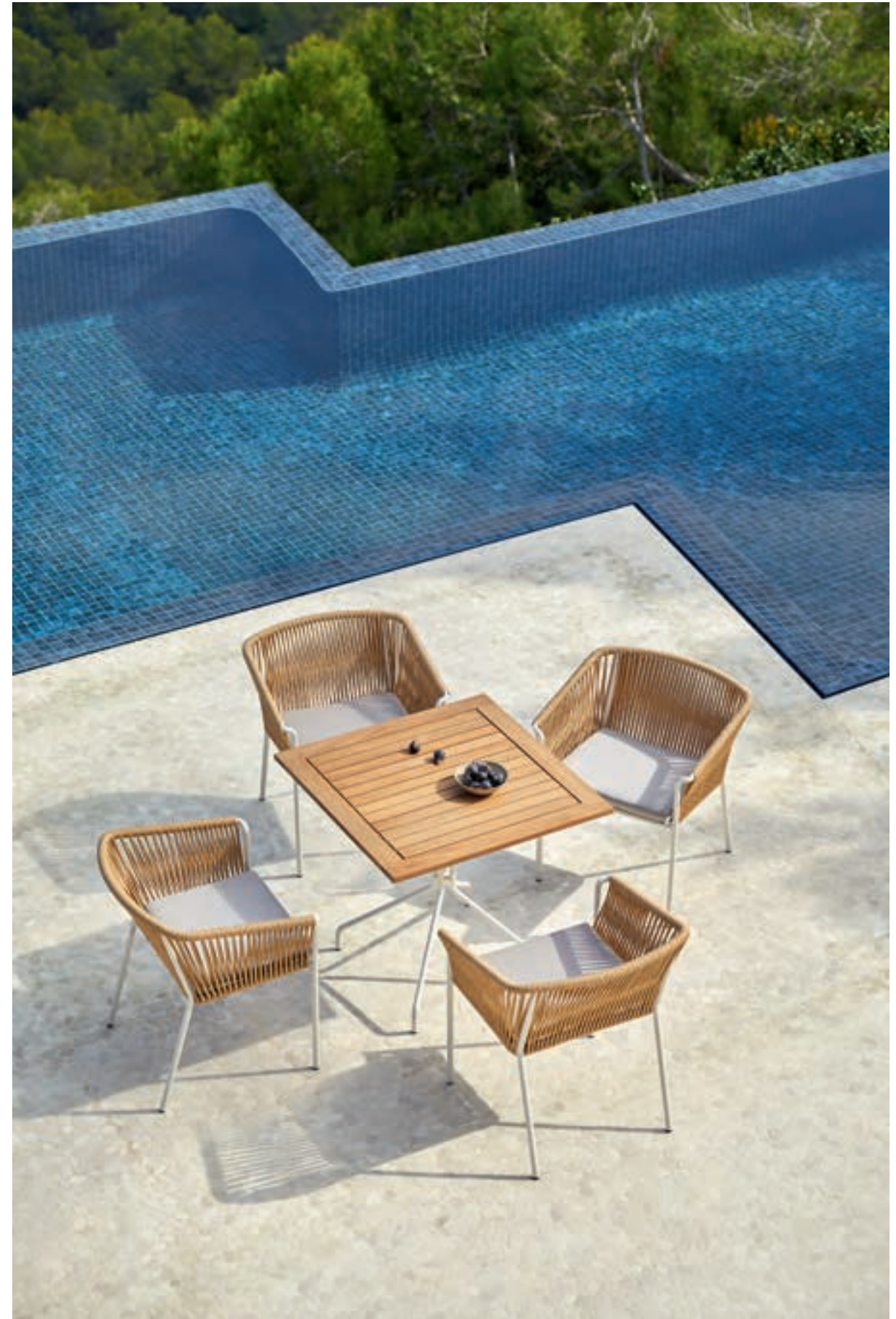



Umbrellas

OMBRA, BEACH & ROMA

POINT STUDIO

TARDES AL SOL

POINT Studio ha desarrollado una completa familia de parasoles con diferentes configuraciones que se adaptan a entornos diversos. Estructuras de aluminio con líneas depuradas, varillas de fibra de vidrio, baldosas de cerámica, hormigón o PVC con ruedas, son los materiales de los que parte cada una de las piezas. Las cubiertas están producidas en tejidos de POINT o en telas Batyline, un tejido sintético y flexible, de alta resistencia a la intemperie y al sol que se seca rápidamente y repele los hongos y las manchas.

AFTERNOONS IN THE SUN

POINT Studio has developed a complete family of different shaped sunshades to suit different settings. Each of the pieces has an aluminum structure with refined lines, fiberglass rods and ceramic, concrete or PVC tiles with wheels. The covers are made with POINT fabrics or Batyline fabrics, a flexible synthetic fabric that is highly resistant to the weather and the sun and which dries quickly and repels fungi and stains.

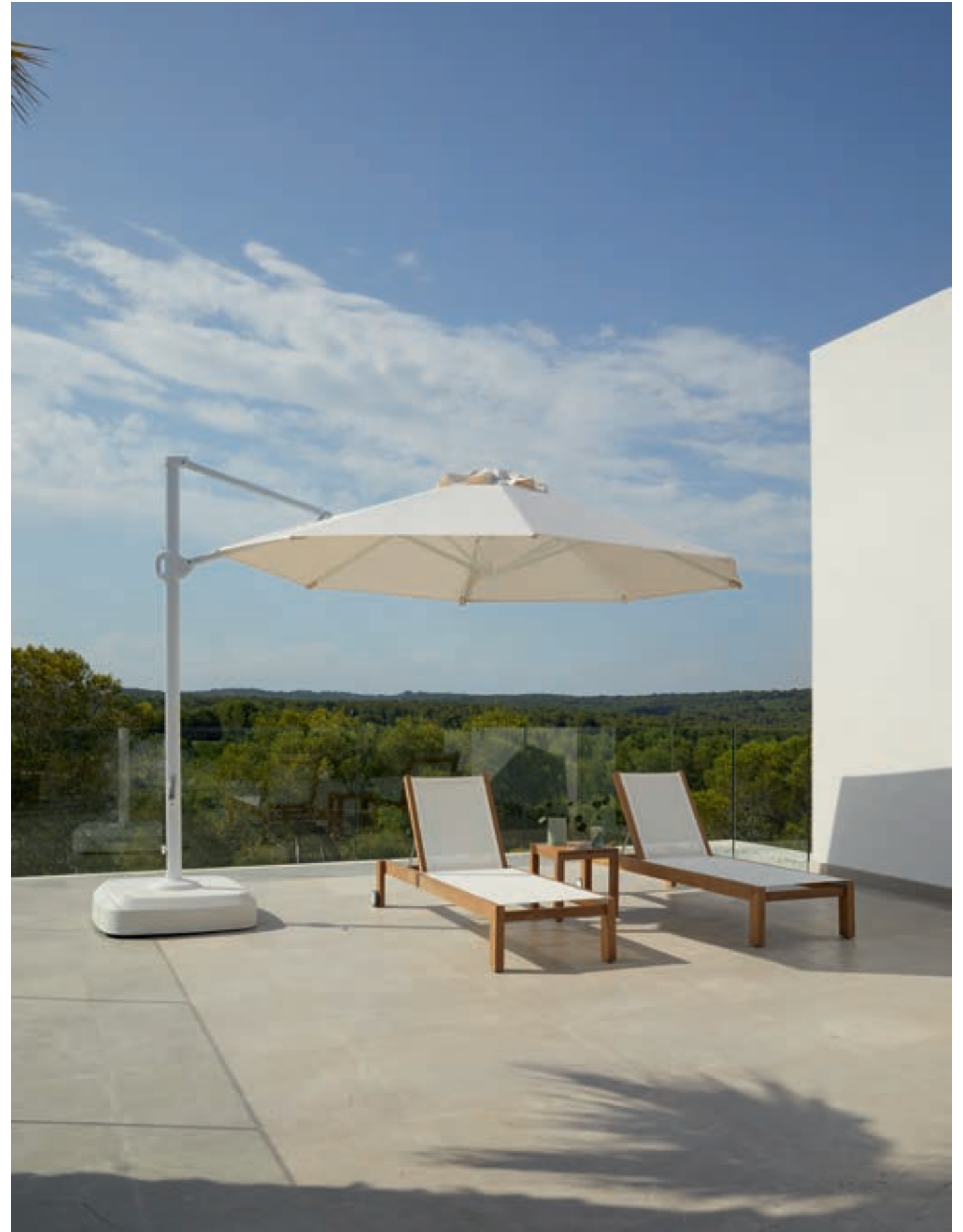



Technical Details

ALGA

SILLÓN COMEDOR ARMCHAIR

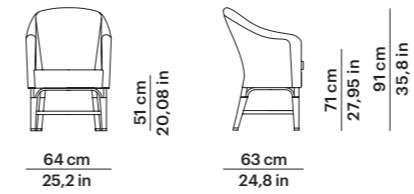

Ref. 71006

Peso Weight **9 Kg 19 lb**
m³ **0,37 m³**

MESA COMEDOR REDONDA ROUND DINING TABLE

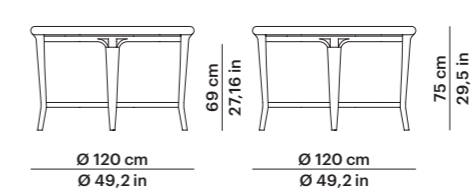

Ref. 71010

Peso Weight **13 Kg s. cristal 28 lb no glass**
28 Kg c. cristal 61 lb w. glass
m³ **1,09 m³s. cristal no glass**
1,16 m³c. cristal w. glass

MESA COMEDOR REDONDA ROUND DINING TABLE

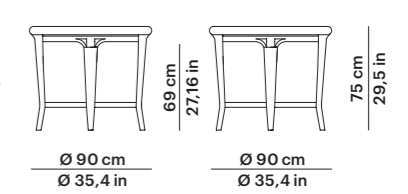

Ref. 71014

Peso Weight **10 Kg s. cristal 22 lb no glass**
23 Kg c. cristal 50 lb w. glass
m³ **0,61 m³s. cristal no glass**
0,65 m³c. cristal w. glass

Materiales y acabados Materials and finishes

Estructura Frame
Aluminio lacado
Lacquered aluminum
Trenzado Weaving
Round Ø 3 mm - Flat oval 6 mm

Acabados Finishes



Tostado 03
Toasted 03

ARC

SILLA SIDE CHAIR

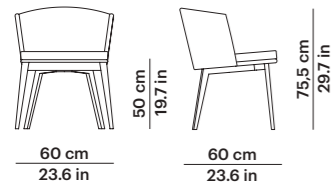

Ref. 76201

Peso Weight 10 Kg 22 lb (1pc)
22 Kg 48.5 lb (2pcs)
m³ 0,39 m³ (1pc) - 0,64 m³ (2pcs)

SILLÓN COMEDOR ARMCHAIR

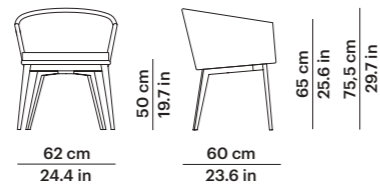

Ref. 76206

Peso Weight 10,5 Kg 23 lb
m³ 0,42 m³

TABURETE BAR STOOL

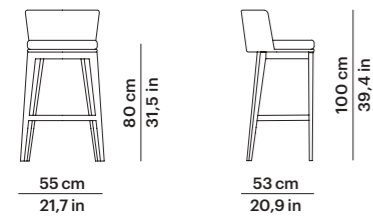

Ref. 76252

Peso Weight 9,9 Kg 21 lb
m³ 0,42 m³

Materiales y acabados Materials and finishes

Estructura Frame
Aluminio lacado Lacquered aluminum
Trenzado Weaving
Flat oval 6 mm
Patas Legs
Teca Natural Natural Teak

Acabados trenzado Weaving finishes



Marfil 36
Ivory 36

Acabados patas Legs finishes



Teca Natural
Natural Teak

ARENA

SILLÓN LOUNGE CHAIR

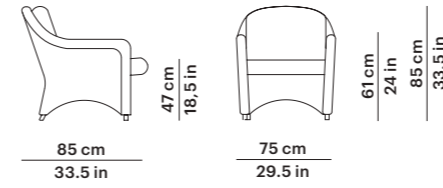

Ref. 70045

Peso Weight 24 Kg 52 lb
m³ 0,52 m³
Cuadrantes 1 (40x40 cm) (15.8x15.8 in)
Scatter cushions

SOFÁ 2 SOFA 2

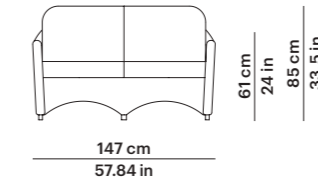

Ref. 70047

Peso Weight 27 Kg 59 lb
m³ 1,01 m³
Cuadrantes 2 (40x40 cm) (15.8x15.8 in)
Scatter cushions

SOFÁ 3 SOFA 3

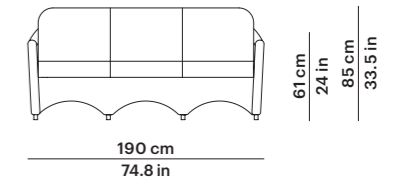

Ref. 70049

Peso Weight 34 Kg 74 lb
m³ 1,32 m³
Cuadrantes 2 (40x40 cm) (15.8x15.8 in)
Scatter cushions

PUF OTTOMAN

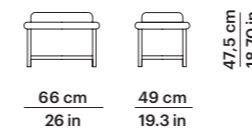

Ref. 70052

Peso Weight 7 Kg 15 lb
m³ 0,15 m³

MESA CENTRO RECTANGULAR RECTANGULAR COFFEE TABLE

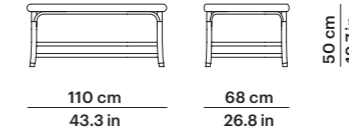

Ref. 70053

Peso Weight 12,30 Kg s. cristal 27 lb no glass
21 Kg c. cristal 46 lb w. glass
m³ 0,36 m³ s. cristal no glass
0,39 m³ c. cristal w. glass

MESA RINCÓN CUADRADA SQUARE SIDE TABLE

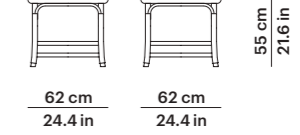

Ref. 70056

Peso Weight 6 Kg s. cristal 13 lb no glass
10 Kg c. cristal 22 lb w. glass
m³ 0,20 m³ s. cristal no glass
0,21 m³ c. cristal w. glass

Materiales y acabados Materials and finishes

Estructura Frame
Aluminio lacado Lacquered aluminum
Trenzado Weaving
Round Ø 3 mm - Flat oval 6 mm

Acabados Finishes



Tostado 03
Toasted 03

BAY

TUMBONA CHAISE

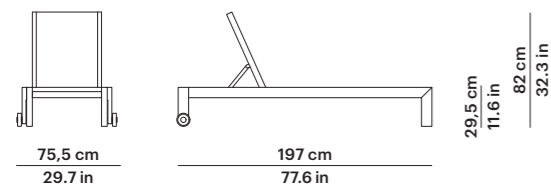

Ref. 78495

Peso Weight 24,4 Kg 53.8 lb (1 pc)
41,8 Kg 92.2 lb (2 pcs)
m³ 0,75 m³ (1 pc)
0,75 m³ (2 pcs)



MESA AUXILIAR SIDE TABLE

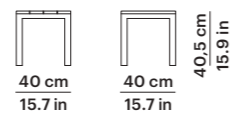

Ref. 78495

Peso Weight 6,3 Kg 13.9 lb
m³ 0,10 m³

Materiales y acabados Materials and finishes

Estructura Frame

Teca natural
Natural teak

Telas Fabrics

Batylne

Acabados Finishes



Teca Natural
Natural Teak

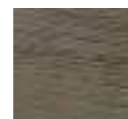

Teca Weathered
Weathered Teak

Acabados telas Fabric finishes



Batylne 35

BREDA

TUMBONA CHAISE

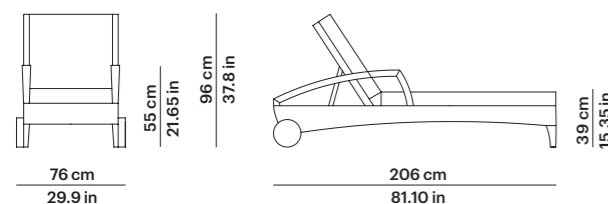

Ref. 72095

Peso Weight 27 Kg 59 lb
m³ 0,9 m³



MESA AUXILIAR SIDE TABLE

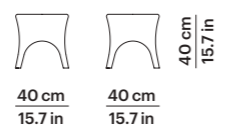

Ref. 72058

Peso Weight 6 Kg s. cristal 13 lb no glass
8 Kg c. cristal 17 lb w. glass
m³ 0,06 m³ s. cristal no glass
0,07 m³ c. cristal w. glass

Materiales y acabados Materials and finishes

Estructura Frame

Aluminio pintado en polvo
Powder coated aluminum

Trenzado Weaving

Flat oval 6 mm

Acabados Finishes

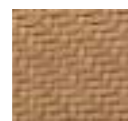

Tostado O3
Toasted O3

BRUMAS

SILLÓN LOUNGE CHAIR

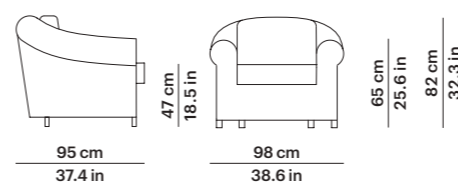

Ref. 71145

Peso Weight 20 Kg 44 lb
m³ 0,68 m³
Cuadrantes 1 (40x40 cm) (15.8x15.8 in)
Scatter cushions

SOFÁ 2 SOFA 2

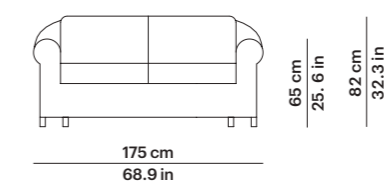

Ref. 71147

Peso Weight 34 Kg 74 lb
m³ 1,30 m³
Cuadrantes 2 (40x40 cm) (15.8x15.8 in)
Scatter cushions

SOFÁ 3 SOFA 3

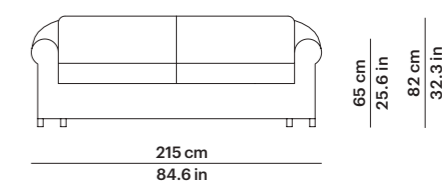

Ref. 71149

Peso Weight 43 Kg 94 lb
m³ 1,59 m³
Cuadrantes 3 (40x40 cm) (15.8x15.8 in)
Scatter cushions

Materiales y acabados Materials and finishes

Estructura Frame

Aluminio lacado
Lacquered aluminum

Trenzado Weaving

Round Ø 3 mm

Acabados Finishes



Tostado O3
Toasted O3

CADDIE

SILLÓN COMEDOR ARMCHAIR

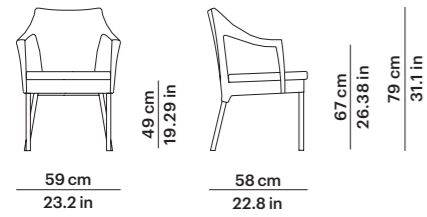

Ref. 71207



Peso Weight 8 Kg (1pc) 17 lb (1pc)
23 Kg (4pc) 50 lb (4pc)
m³ 0,31 m³ (1pc) - 0,5 m³ (4pc)

Materiales Materials

Estructura Frame
Aluminio lacado
Lacquered aluminum
Trenzado Weaving
Flat oval 6 mm

Acabados Finishes



Marfil 36
Ivory 36

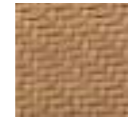

Tostado 03
Toasted 03

CHARLESTON

SILLÓN COMEDOR ARMCHAIR

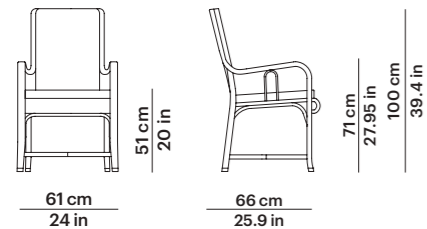

Ref. 73306

Peso Weight 8,5 Kg 18 lb
m³ 0,4 m³

Materiales y acabados Materials and finishes

Estructura Frame
Aluminio lacado
Lacquered aluminum
Trenzado Weaving
Flat oval 6 mm

Acabados Finishes

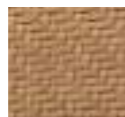

Tostado 03
Toasted 03

CITY

SILLÓN LOUNGE CHAIR

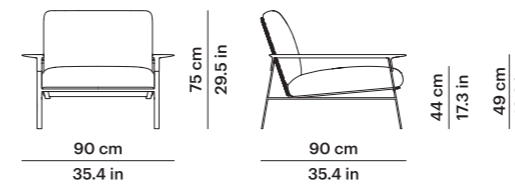

Ref. 78345

Peso Weight 26,6 Kg 58.6 lb
m³ 0,85 m³
Cuadrantes 1 (60x35 cm) (23.6x13.7 in)
Scatter cushions

SOFÁ 2 SOFA 2

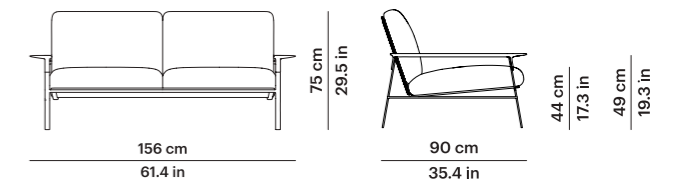

Ref. 78347

Peso Weight 45,5 Kg 100 lb
m³ 1,41 m³
Cuadrantes 2 (60x35 cm) (23.6x13.7 in)
Scatter cushions

SOFÁ 3 SOFA 3

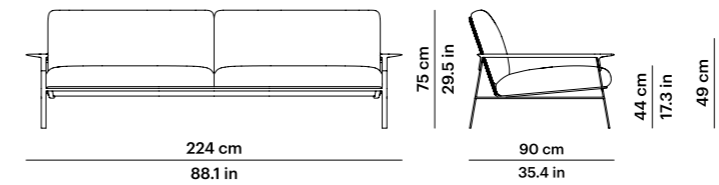

Ref. 78349

Peso Weight 57,8 Kg 127.4 lb
m³ 2 m³
Cuadrantes 2 (60x35 cm) (23.6x13.7 in)
Scatter cushions 2 (40x40 cm) (15.8x15.8 in)

Materiales y acabados Materials and finishes

Estructura
Frame



Teca Natural
Natural Teak

Aluminio pintado en polvo Powder coated aluminum
Cuerda Ø4 mm Rope Ø4 mm



Blanco Mineral 34
Mineral White 34
Beige
Beige

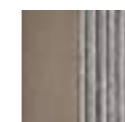

Arena 74
Sand 74
Gris Perlado
Pearl Grey



Gris Metalizado 56
Gunmetal Grey 56
Grafito
Graphite

CITY

MESA CENTRO CUADRADA SQUARE COFFEE TABLE

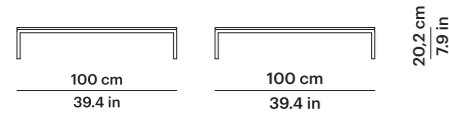

Ref. 78353

Peso Weight 39,2 Kg con tapa porcelánico
86.4 lb with porcelain top
28,2 Kg con tapa compacto
62.2 lb with HPL top
m³ 0,42 m³

MESA CENTRO RECTANGULAR RECTANGULAR COFFEE TABLE

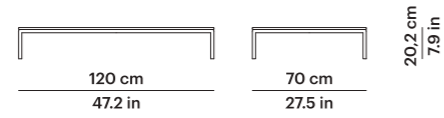

Ref. 78354

Peso Weight 37,1 Kg con tapa porcelánico
81.8 lb with porcelain top
28,7 Kg con tapa compacto
61.3 lb with HPL top
m³ 0,36 m³

MESA RINCÓN CUADRADA SQUARE SIDE TABLE

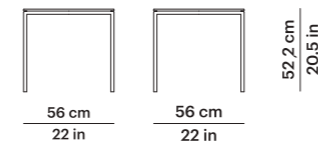

Ref. 78356

Peso Weight 16,7 Kg con tapa porcelánico
36.8 lb with porcelain top
13,3 Kg con tapa compacto
29.3 lb with HPL top
m³ 0,28 m³

MESA RINCÓN REDONDA ROUND SIDE TABLE

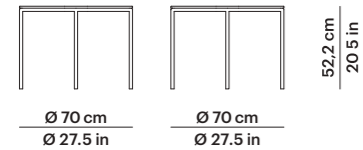

Ref. 78357

Peso Weight 20,8 Kg con tapa porcelánico
45.8 lb with porcelain top
15,4 Kg con tapa compacto
34 lb with HPL top
m³ 0,41 m³

Materiales y acabados Materials and finishes

Estructura Frame	Tapa Top Compacto HPL						
Aluminio pintado en polvo Powder coated aluminum							
	Beige Beige	Negro Black	Blanco Marmolizado Marbled White	Madera Wood	Taupe Monocolor Solid Taupe	Blanco Monocolor Solid White	
	Tapa Top Porcelánico Porcelain						
Arena 74 Sand 74	Blanco Natural 81 Natural White 81	Gris Lava 82 Lava Grey 82	Blanco Roto Veteado 85 Veined Off White 85	Gris Basalto 86 Basalt Grey 86	Gris Ocre 87 Ochre Grey 87		
Gris Metalizado 56 Gunmetal Grey 56							

COLORS

PIE DE MESA TABLE BASE

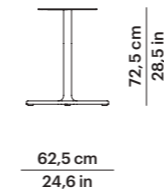

Ref. 74214

Peso Weight 13,5 Kg 29 lb
m³ 0,37 m³
Medida tapa Ø 70 - Ø 80 - Ø 90 cm
Top size 70x70 - 80x80 - 90x90 cm
Ø 27.6 - Ø 31.5 - Ø 35.4 In
27.6x27.6 - 31.5x31.5 - 35.4x35.4 In

PIE DE MESA DOBLE DOUBLE TABLE BASE

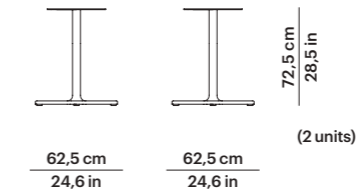

Ref. 74208

Peso Weight 27 Kg 59.5 lb
m³ 0,74 m³
Medida tapa 160x90 cm
Top size 63x35.4 In

Materiales y acabados Materials and finishes

Estructura Frame
Aluminio pintado en polvo
Powder coated aluminum

Acabados Finishes

Blanco Nieve 70 White Snow 70	Blanco Mineral 34 Mineral White 34	Tostado 03 Toasted 03	Arena 74 Sand 74
Óxido 75 Oxide 75	Taupe 60 Taupe 60	Gris Metalizado 56 Gunmetal Grey 56	Negro 59 Black 59
Terracota 72 Terracotta 72	Verde Ficus 73 Green Ficus 73	Azul Cielo 71 Blue Sky 71	

FUP

PUF OTTOMAN

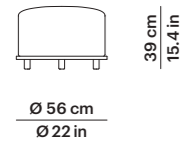

Ref. 77751

Peso Weight 8,4 Kg 18.5 lb
m³ 0,18 m³

PUF OTTOMAN

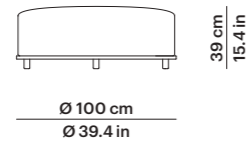

Ref. 77752

Peso Weight 25,8 Kg 56.9 lb
m³ 0,46 m³

Materiales y acabados Materials and finishes

Estructura Frame



Teca Natural
Natural Teak

HAMP

SILLÓN COMEDOR ARMCHAIR

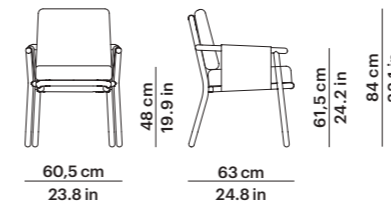

Ref. 76706

Peso Weight 10 Kg 22 lb
m³ 0,4 m³

SILLÓN LOUNGE CHAIR

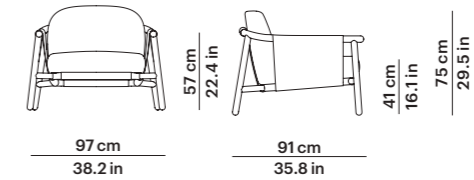

Ref. 76745

Peso Weight 21 Kg 46 lb
m³ 0,86 m³
Cuadrantes 1 (50x50 cm) (19.7x19.7 in)
Scatter cushions

SOFÁ 2 SOFA 2

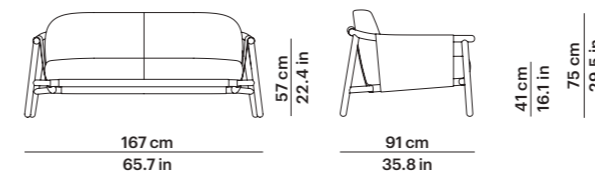

Ref. 76747

Peso Weight 32 Kg 70 lb
m³ 1,44 m³
Cuadrantes Scatter cushions 2 (50x50 cm) (19.7x19.7 in)

Materiales y acabados Materials and finishes

Estructura Frame

Teca natural
Natural teak
Telas Fabrics
Batyline

Acabados telas Fabric finishes



Batyline 13



Batyline 09



Batyline 10



Batyline 11

Acabado estructura Frame finishes



Teca Natural
Natural Teak

HAVANA

SILLÓN COMEDOR ARMCHAIR

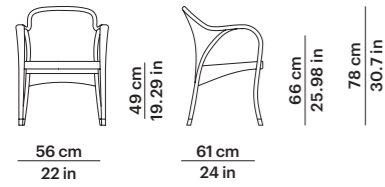

Ref. 73307

Peso Weight 5,5 Kg 12 lb
m³ 0,27 m³

Materiales y acabados Materials and finishes

Estructura Frame
Aluminio Lacquered aluminum
Trenzado Weaving
Round Ø 2 mm - Flat oval 6 mm

Acabados trenzado Weaving finishes



Marfil 36
Ivory 36



Dark 59
Dark 59

HERITAGE

SILLA SIDE CHAIR

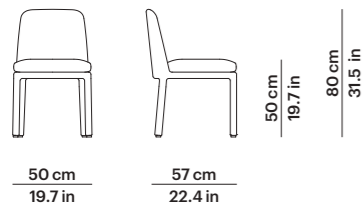

Ref. 78601

Peso Weight 8,7 Kg 19.2 lb
m³ 0,30 m³

SILLÓN COMEDOR ARMCHAIR

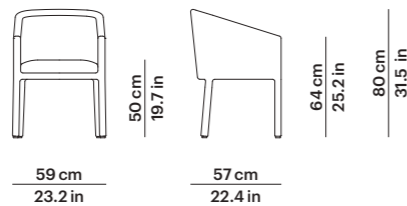

Ref. 78606

Peso Weight 11,3 Kg 24,9 lb
m³ 0,35 m³

SILLÓN COMEDOR ARMCHAIR

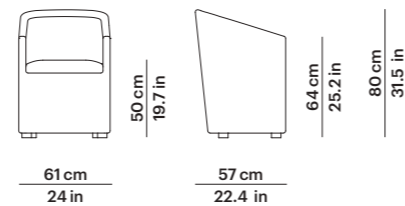

Ref. 78506

Peso Weight 14,9 Kg 32.8 lb
m³ 0,36 m³

Materiales y acabados Materials and finishes

Estructura Frame
Aluminio Lacquered aluminum
Trenzado Weaving
Round Ø 6 mm

Acabados trenzado Weaving finishes

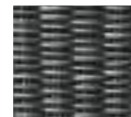

Ash Grey

HERITAGE

SILLÓN LOUNGE CHAIR

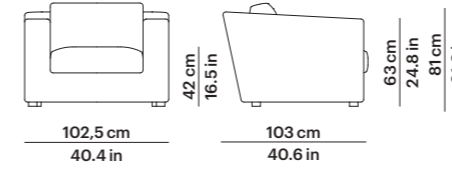

Ref. 78545

Peso Weight 33,7 Kg 74.3 lb
m³ 1,03 m³
Cuadrantes Scatter cushions
1 (40x40 cm) (15.8x15.8 in)

SOFÁ 2 SOFA 2

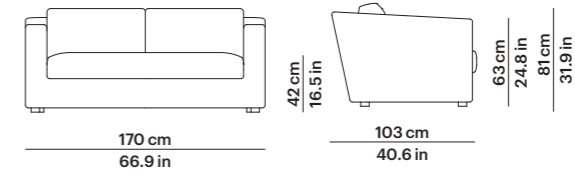

Ref. 78547

Peso Weight 48,6 Kg 107.1 lb
m³ 1,67 m³
Cuadrantes Scatter cushions
2 (40x40 cm) (15.8x15.8 in)

SOFÁ 2 MODULAR BRAZO DERECHO RIGTH ARM SECTIONAL SOFA 2

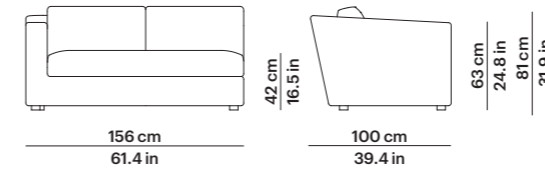

Ref. 78544

Peso Weight 49,6 Kg 109,3 lb
m³ 1,48 m³
Cuadrantes Scatter cushions
1 (40x40 cm) (15.8x15.8 in)

SOFÁ 2 MODULAR BRAZO IZQUIERDO LEFT ARM SECTIONAL SOFA 2

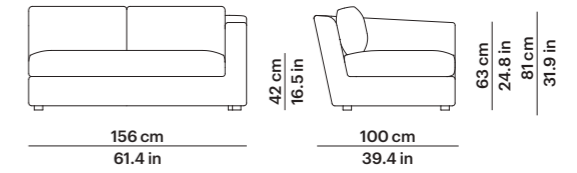

Ref. 78546

Peso Weight 49,6 Kg 109,3 lb
m³ 1,48 m³
Cuadrantes Scatter cushions
1 (40x40 cm) (15.8x15.8 in)

RINCONERA CORNER

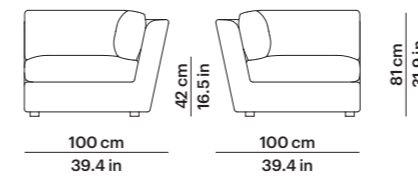

Ref. 78551

Peso Weight 33,7 Kg 74.3 lb
m³ 0,98 m³

Materiales y acabados Materials and finishes

Estructura Frame
Aluminio Lacquered aluminum
Trenzado Weaving
Round Ø 6 mm

Acabados trenzado Weaving finishes

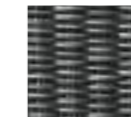

Ash Grey

HERITAGE

SOFÁ 3 SOFA 3

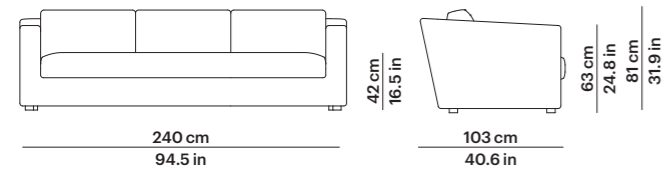

Ref. 78549

Peso Weight 72,8 Kg 160.5 lb
 m³ 2,33 m³
 Cuadrantes Scatter cushions 2 (40x40 cm) (15.8x15.8 in)

SOFÁ 3 MODULAR BRAZO DERECHO RIGH ARM SECTIONAL SOFA 3

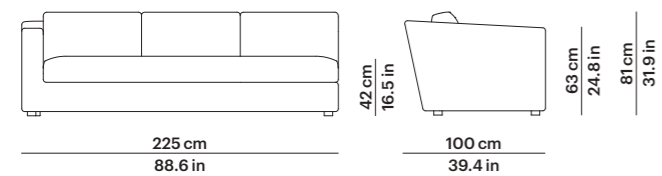

Ref. 78542

Peso Weight 64.4 Kg 142 lb
 m³ 2,13 m³
 Cuadrantes Scatter cushions 1 (40x40 cm) (15.8x15.8 in)

SOFÁ 3 MODULAR BRAZO IZQUIERDO LEFT ARM SECTIONAL SOFA 3

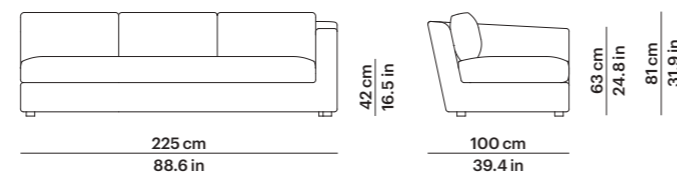

Ref. 78543

Peso Weight 64.4 Kg 142 lb
 m³ 2,13 m³
 Cuadrantes Scatter cushions 1 (40x40 cm) (15.8x15.8 in)

Materiales y acabados Materials and finishes

Estructura Frame
 Aluminio Lacquered aluminum
 Trenzado Weaving
 Round Ø 6 mm

Acabados trenzado Weaving finishes



Ash Grey

HERITAGE

SILLÓN CLUB CURVO CURVED CLUB LOUNGE CHAIR

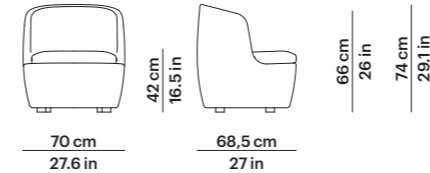

Ref. 78705

Peso Weight 19,5 Kg 43 lb
 m³ 0,45 m³

SOFÁ 2 CURVO CURVED SOFA 2

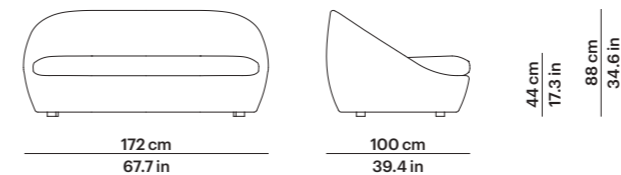

Ref. 78747

Peso Weight 50,6 Kg 111.6 lb
 m³ 1,77 m³
 Cuadrantes Scatter cushions 2 (70x50 cm) (23.6x19.7 in)
 2 (40x40 cm) (15.8x15.8 in)

Materiales y acabados Materials and finishes

Estructura Frame
 Aluminio Lacquered aluminum
 Trenzado Weaving
 Round Ø 6 mm

Acabados trenzado Weaving finishes



Ash Grey

SILLÓN CURVO CURVED LOUNGE CHAIR

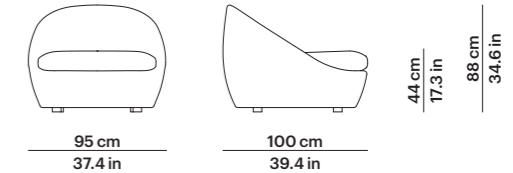

Ref. 78745

Peso Weight 28,3 Kg 62.4 lb
 m³ 1,01 m³
 Cuadrantes Scatter cushions 1 (50x50 cm) (19.7x19.7 in)
 1 (40x40 cm) (15.8x15.8 in)

SOFÁ 3 CURVO CURVED SOFA 3

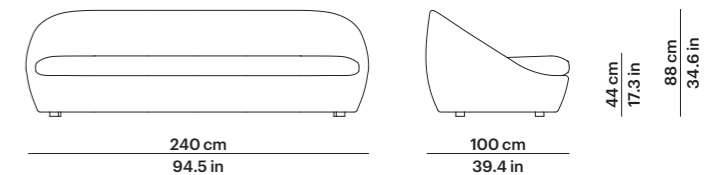

Ref. 78749

Peso Weight 66,6 Kg 146.8 lb
 m³ 2,45 m³
 Cuadrantes Scatter cushions 3 (70x50 cm) (23.6x19.7 in)
 2 (40x40 cm) (15.8x15.8 in)

Materiales y acabados Materials and finishes

Estructura Frame
 Aluminio Lacquered aluminum
 Trenzado Weaving
 Round Ø 6 mm

Acabados trenzado Weaving finishes



Ash Grey

HERITAGE

TUMBONA CHAISE

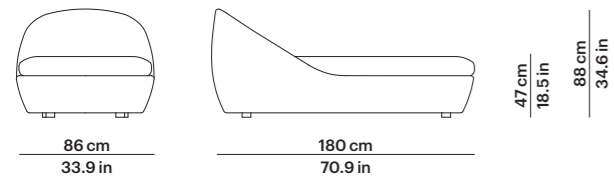

Ref. 78795
Peso Weight 39,4 Kg 86.9 lb
m³ 1,61 m³
Cuadrantes Scatter cushions 1 (50x50 cm) (19.7x19.7 in)
 1 (40x40 cm) (15.8x15.8 in)

TUMBONA DAYBED

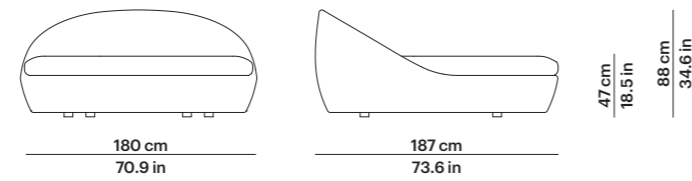

Ref. 78796
Peso Weight 66,1 Kg 145.7 lb
m³ 3,37 m³
Cuadrantes Scatter cushions 2 (70x50 cm) (23.6x19.7 in)
 3 (40x40 cm) (15.8x15.8 in)

TUMBONA CHAISE

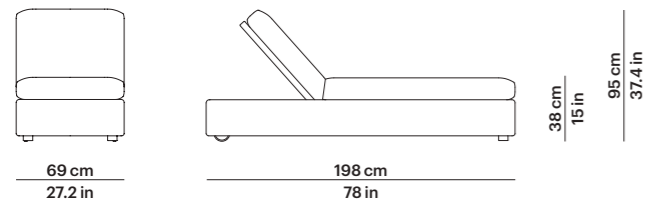

Ref. 78595
Peso Weight 38,6 Kg 85.1 lb
m³ 0,65 m³

TUMBONA CON BRAZOS CHAISE WITH ARMS

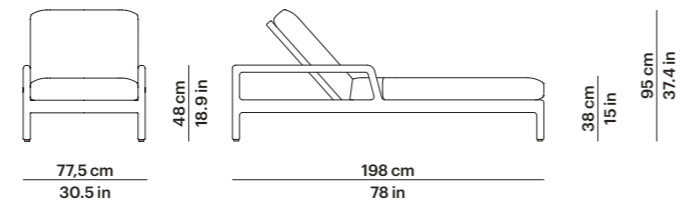

Ref. 78696
Peso Weight 38,8 Kg 85.5 lb
m³ 0,80 m³

Materiales y acabados Materials and finishes

Estructura Frame
 Aluminio Lacquered aluminum
Trenzado Weaving
 Round Ø 6 mm

Acabados trenzado Weaving finishes

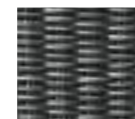

Ash Grey

HERITAGE

MESA RINCÓN CUADRADA SQUARE SIDE TABLE

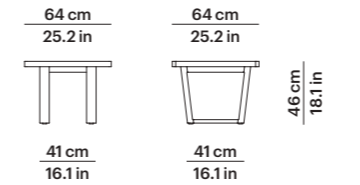

Tapa teca
 Teak top
Tapa porcelánico y compacto
 Porcelain and HPL top

Ref. 78556

Peso Weight 15,6 Kg con tapa teca
 34.39 lb with teak top
 27,86 Kg con tapa porcelánico
 61.41 lb with porcelain top
 22,76 Kg con tapa compacto
 50.17 lb with HPL top
m³ 0,25 m³

MESA AUXILIAR SIDE TABLE

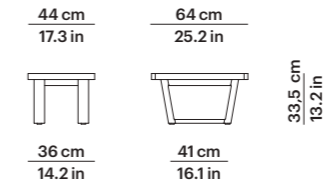

Tapa teca
 Teak top
Tapa porcelánico y compacto
 Porcelain and HPL top

Ref. 78555

Peso Weight 13,4 Kg con tapa teca
 29.54 lb with teak top
 22,54 Kg con tapa porcelánico
 49.70 lb with porcelain top
 19,16 Kg con tapa compacto
 42.24 lb with HPL top
m³ 0,14 m³

Materiales y acabados Materials and finishes

Estructura Frame



Teca Natural
 Natural Teak

Tapa Top Compacto HPL



Beige Beige



Negro Black

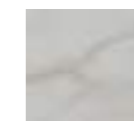

Blanco Marmolizado
 Marbled White



Madera Wood



Taupe Monocolor
 Solid Taupe

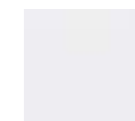

Blanco Monocolor
 Solid White

Tapa Top Porcelánico Porcelain

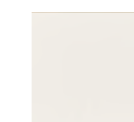

Blanco Natural 81
 Natural White 81

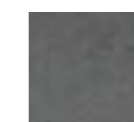

Gris Lava 82
 Lava Grey 82



Blanco Roto
 Vetado 85
 Veined Off White 85

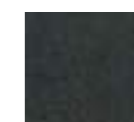

Gris Basalto 86
 Basalt Grey 86

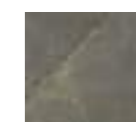

Gris Ocre 87
 Ochre Grey 87

HERITAGE

MESA CENTRO RECTANGULAR RECTANGULAR COFFEE TABLE

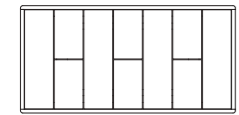
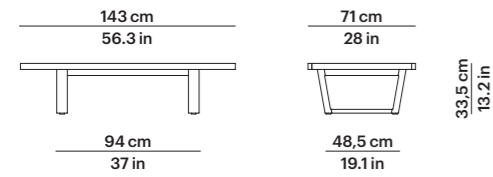

Tapa teca
Teak top



Tapa porcelánico y compacto
Porcelain and HPL top

Ref. 78554

Peso Weight 26,4 Kg con tapa teca
58.20 lb with teak top
53,01 Kg con tapa porcelánico
116.86 lb with porcelain top
39,56 Kg con tapa compacto
87.20 lb with HPL top
m³ 0,45 m³

MESA CENTRO CUADRADA SQUARE COFFEE TABLE

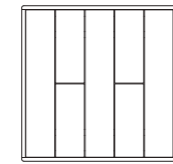
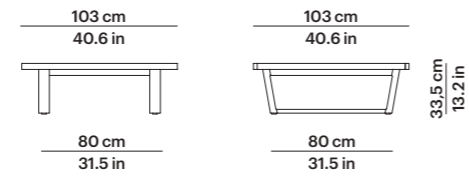

Tapa teca
Teak top

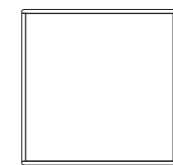

Tapa porcelánico y compacto
Porcelain and HPL top

Ref. 78553

Peso Weight 33,6 Kg con tapa teca
74.08 lb with teak top
51,57 Kg con tapa porcelánico
113.69 lb with porcelain top
37,31 Kg con tapa compacto
82.25 lb with HPL top
m³ 0,47 m³

HERITAGE

MESA COMEDOR REDONDA ROUND DINING TABLE

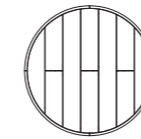
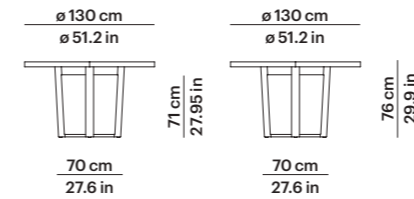

Tapa teca
Teak top

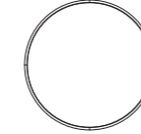

Tapa porcelánico y compacto
Porcelain and HPL top

Ref. 78511

Peso Weight 43,4 Kg con tapa teca
95.68 lb with teak top
74,87 Kg con tapa porcelánico
165.07 lb with porcelain top
56,32 Kg con tapa compacto
124.16 lb with HPL top
m³ 0,51 m³

MESA COMEDOR CUADRADA SQUARE DINING TABLE

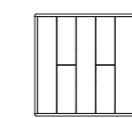
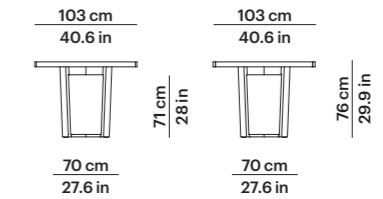

Tapa teca
Teak top

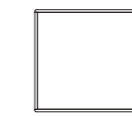

Tapa porcelánico y compacto
Porcelain and HPL top

Ref. 78510

Peso Weight 41,4 Kg con tapa teca
91.27 lb with teak top
55,57 Kg con tapa porcelánico
122.51 lb with porcelain top
41,31 Kg con tapa compacto
91.07 lb with HPL top
m³ 0,33 m³

Materiales y acabados Materials and finishes

Estructura Frame



Teca Natural
Natural Teak

Tapa Top Compacto HPL



Beige Beige



Negro Black

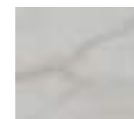

Blanco Marmolizado
Marbled White



Madera Wood



Taupe Monocolor
Solid Taupe

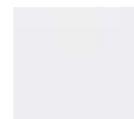

Blanco Monocolor
Solid White

Tapa Top Porcelánico Porcelain

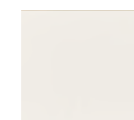

Blanco Natural 81
Natural White 81

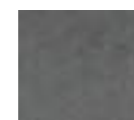

Gris Lava 82
Lava Grey 82



Blanco Roto
Veteado 85
Veined Off White 85

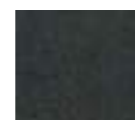

Gris Basalto 86
Basalt Grey 86

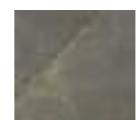

Gris Ocre 87
Ochre Grey 87

Materiales y acabados Materials and finishes

Estructura Frame



Teca Natural
Natural Teak

Tapa Top Compacto HPL



Beige Beige



Negro Black

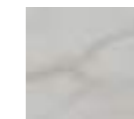

Blanco Marmolizado
Marbled White



Madera Wood



Taupe Monocolor
Solid Taupe

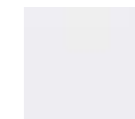

Blanco Monocolor
Solid White

Tapa Top Porcelánico Porcelain

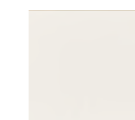

Blanco Natural 81
Natural White 81

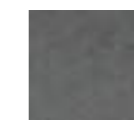

Gris Lava 82
Lava Grey 82



Blanco Roto
Veteado 85
Veined Off White 85



Gris Basalto 86
Basalt Grey 86

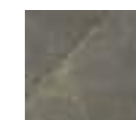

Gris Ocre 87
Ochre Grey 87

HERITAGE

MESA COMEDOR RECTANGULAR RECTANGULAR DINING TABLE

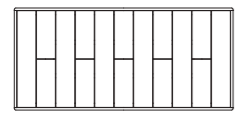
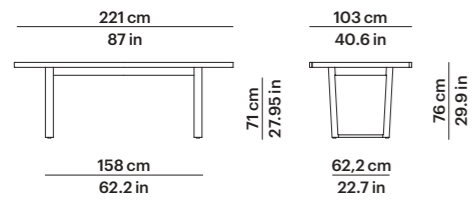

Tapa teca
Teak top



Tapa porcelánico y compacto
Porcelain and HPL top

Ref. 78508

Peso Weight **78,2 Kg con tapa teca**
172.40 lb with teak top
125,82 Kg con tapa porcelánico
277.38 lb with porcelain top
94,36 Kg con tapa compacto
208.03 lb with HPL top
m³ **0,62 m³**

MESA COMEDOR RECTANGULAR RECTANGULAR DINING TABLE

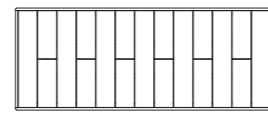
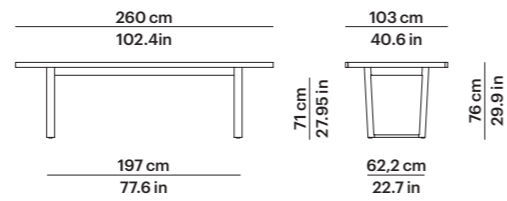

Tapa teca
Teak top



Tapa porcelánico y compacto
Porcelain and HPL top

Ref. 78509

Peso Weight **84,8 Kg con tapa teca**
186.95 lb with teak top
143,9 Kg con tapa porcelánico
317.25 lb with porcelain top
106,71 Kg con tapa compacto
235.26 lb with HPL top
m³ **0,75 m³**

Materiales y acabados Materials and finishes

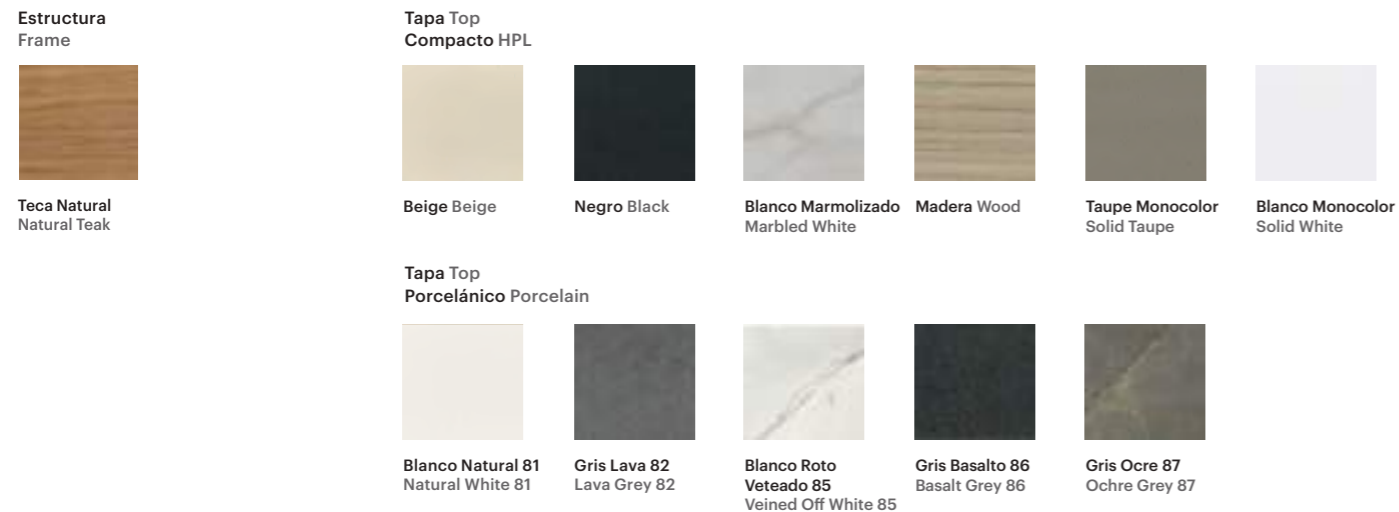

HERITAGE

MESA AUXILIAR TEJIDA WOVEN SIDE TABLE

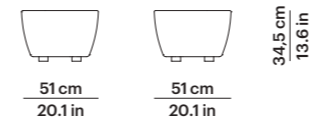

Tapa teca
Teak top

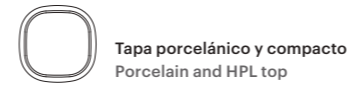

Tapa porcelánico y compacto
Porcelain and HPL top

Ref. 78756

Peso Weight **10,4 Kg con tapa teca**
22.93 lb with teak top
11,47 Kg tapa porcelánico
25.28 lb porcelain top
9,16 Kg tapa compacto
20.19 lb HPL top
m³ **0,13 m³**

MESA CENTRO RECTANGULAR TEJIDA RECTANGULAR WOVEN COFFEE TABLE

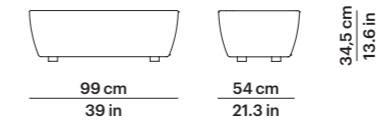

Tapa teca
Teak top



Tapa porcelánico y compacto
Porcelain and HPL top

Ref. 78755

Peso Weight **17 Kg con tapa teca**
37.48 lb with teak top
21,63 Kg tapa porcelánico
47.68 lb porcelain top
16,23 Kg tapa compacto
35.79 lb HPL top
m³ **0,26 m³**

MESA CENTRO CUADRADA TEJIDA SQUARE WOVEN COFFEE TABLE

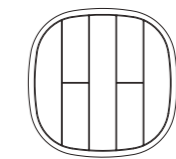
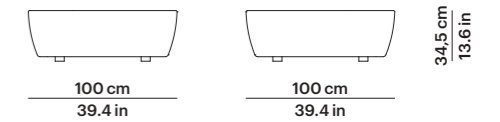

Tapa teca
Teak top

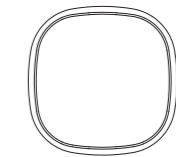

Tapa porcelánico y compacto
Porcelain and HPL top

Ref. 78753

Peso Weight **29,6 Kg con tapa teca**
65.26 lb with teak top
38,64 Kg tapa porcelánico
85.18 lb porcelain top
28,07 Kg tapa compacto
61.88 lb HPL top
m³ **0,46 m³**

Materiales y acabados Materials and finishes

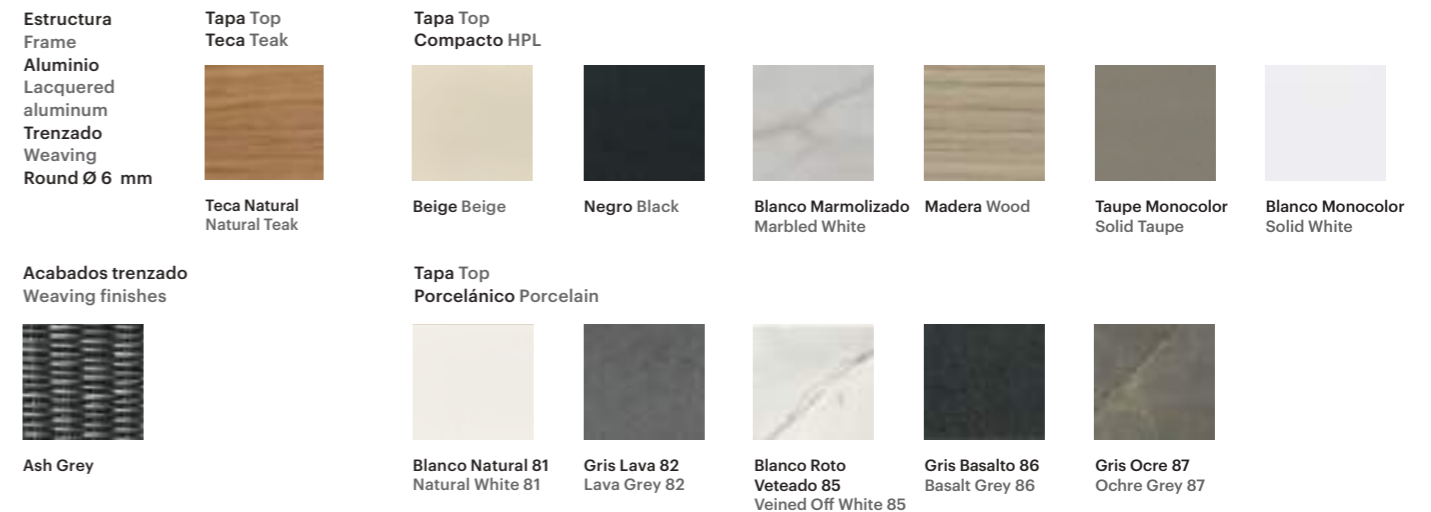

KAHN

TUMBONA CHAISE

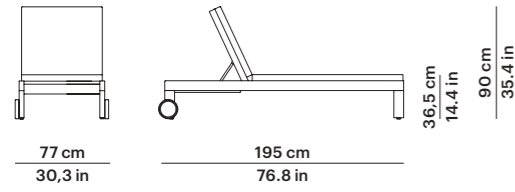

Ref. 79896

Peso Weight 47 Kg 103.6 lb
m³ 0,66 m³



TUMBONA BATYLINE CHAISE

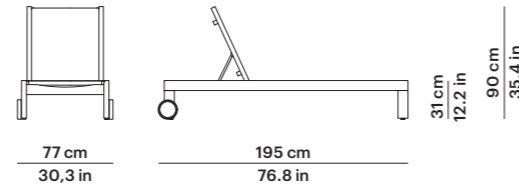

Ref. 79895

Peso Weight 30 Kg 66.1 lb
m³ 0,66 m³



TUMBONA DOBLE SIN CORTINAS DOUBLE CHAISE WITH NO CURTAINS

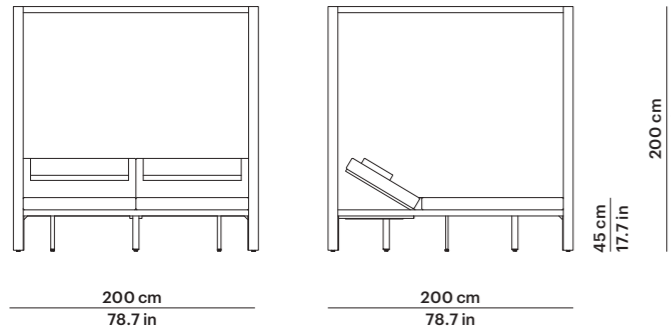

Ref. 79893

Peso Weight 121,8 Kg 268.5 lb
m³ 1,95 m³



TUMBONA DOBLE CON CORTINAS DOUBLE CHAISE WITH CURTAINS

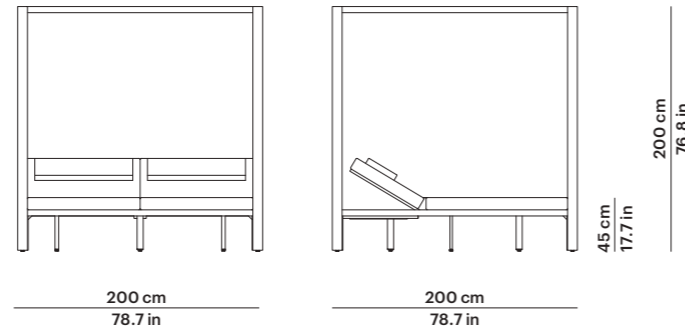

Ref. 79894

Peso Weight 130,8 Kg 286.6 lb
m³ 1,95 m³



MESA AUXILIAR SIDE TABLE

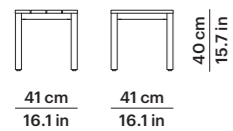

Ref. 79858

Peso Weight 9 Kg 19.8 lb
m³ 0.05 m³

Materiales y acabados Materials and finishes

Estructura Frame



TechTeak

Acabados telas Fabric finishes



Batyline 35

KHAI

SILLÓN COMEDOR ARMCHAIR

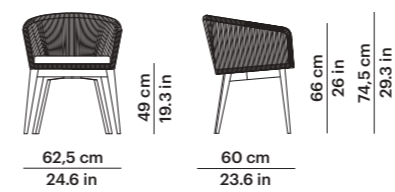

Ref. 78806

Peso Weight 12,7 Kg 28 lb
m³ 0,36 m³

Materiales y acabados Materials and finishes

Estructura Frame
Aluminio Lacquered aluminum
Trenzado Weaving
Round Ø 8 mm
Patas Legs
Teca natural Natural teak

Tapa Top
Teca Teak



Teca Natural
Natural Teak

Acabados trenzado
Weaving finishes

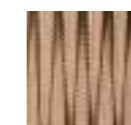

Turrón
Nougat

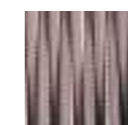

Taupe
Taupe



Negro
Black

KUBIK

SILLÓN COMEDOR ARMCHAIR

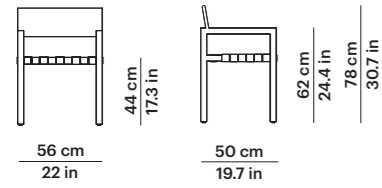

Ref. 79606

Peso Weight 11 Kg 24.3 lb (1pc)
26 Kg 57.3 lb (2pcs)
m³ 0,29 m³ (1pc) - 0,56 m³ (2pcs)

SOFÁ 2 SOFA 2

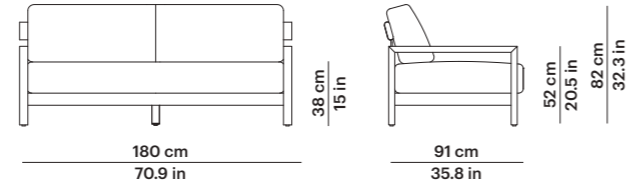

Ref. 79647

Peso Weight 67,8 Kg 149.5 lb
m³ 1,4 m³
Cuadrantes Scatter cushions 2 (40x40 cm) (15.8x15.8 in)
2 (55x30 cm) (21.6x11.8 in)

SILLÓN LOUNGE CHAIR

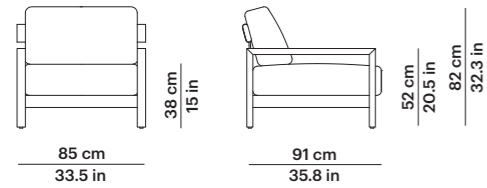

Ref. 79645

Peso Weight 34 Kg 75 lb
m³ 0,7 m³
Cuadrantes Scatter cushions 1 (55x30 cm) (21.6x11.8 in)

SOFÁ 3 SOFA 3

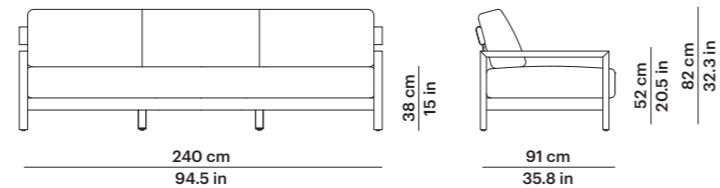

Ref. 79649

Peso Weight 86,3 Kg 190.3 lb
m³ 1,85 m³
Cuadrantes Scatter cushions 2 (40x40 cm) (15.8x15.8 in)
2 (55x30 cm) (21.6x11.8 in)

KUBIK

MESA RINCÓN CUADRADA SQUARE SIDE TABLE

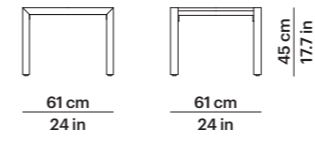

Ref. 79658

Peso Weight 16 Kg
35.3lb
m³ 0,14 m³

MESA RINCÓN CUADRADA SQUARE SIDE TABLE

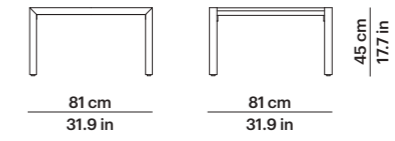

Ref. 79656

Peso Weight 26,5 Kg
58.4 lb
m³ 0,16 m³

MESA CENTRO CUADRADA SQUARE COFFEE TABLE

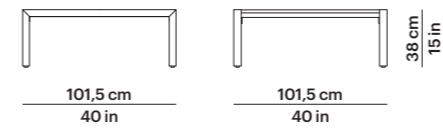

Ref. 79653

Peso Weight 35 Kg
77.2 lb
m³ 0,24 m³

MESA CENTRO RECTANGULAR RECTANGULAR COFFEE TABLE

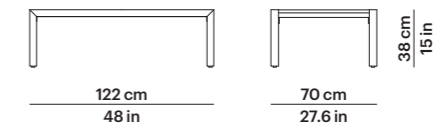

Ref. 79654

Peso Weight 30,5 Kg
67.2 lb
m³ 0,19 m³

Materiales y acabados Materials and finishes

Estructura Frame
TechTeak



TechTeak

Materiales y acabados Materials and finishes

Estructura Frame
TechTeak



TechTeak

KUBIK

MESA COMEDOR CUADRADA SQUARE DINING TABLE

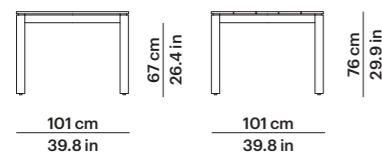

Ref. 79610

Peso Weight 46 Kg
101 lb
m³ 0,24 m³

MESA COMEDOR RECTANGULAR RECTANGULAR DINING TABLE

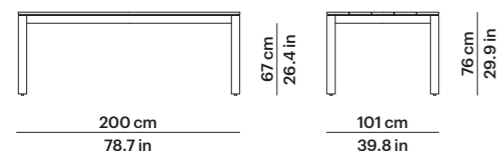

Ref. 79608

Peso Weight 73 Kg
160.9
m³ 0,45 m³

MESA COMEDOR RECTANGULAR RECTANGULAR DINING TABLE

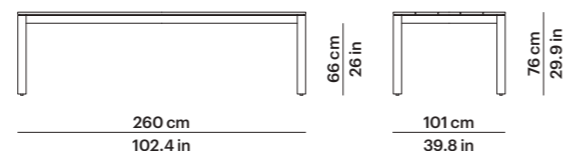

Ref. 79609

Peso Weight 93 Kg
205 lb
m³ 0,57 m³

Materiales y acabados Materials and finishes

Estructura Frame
TechTeak



TechTeak

LEGACY

SILLÓN LOUNGE CHAIR

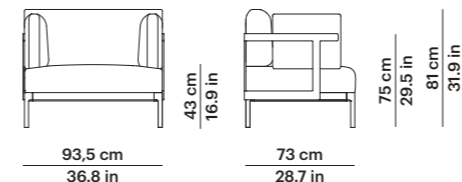

Ref. 79345

Peso Weight 35,4 Kg 78 lb
m³ 0,7 m³
Cuadrantes 1 (40x40 cm) (15.8x15.8 in)
Scatter cushions

SOFÁ 2 SOFA 2

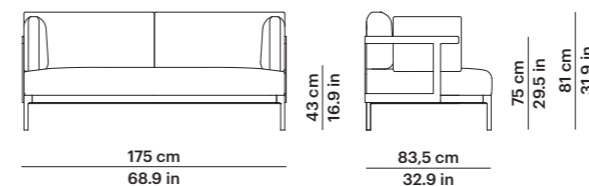

Ref. 79347

Peso Weight 60,4 Kg 133.2 lb
m³ 1,4 m³
Cuadrantes 2 (40x40 cm) (15.8x15.8 in)
Scatter cushions

SOFÁ 3 SOFA 3

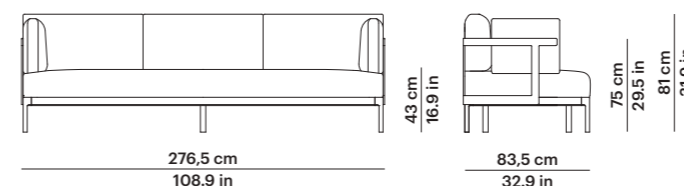

Ref. 79349

Peso Weight 89,8 Kg 198 lb
m³ 2,3 m³
Cuadrantes 5 (40x40 cm) (15.8x15.8 in)
Scatter cushions

SILLÓN LOUNGE CHAIR

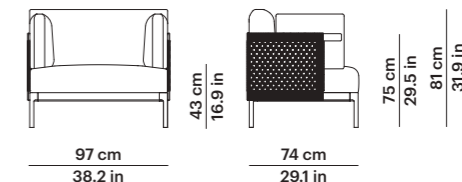

Ref. 79445

Peso Weight 33,4 Kg 73.6 lb
m³ 0,7 m³
Cuadrantes 1 (40x40 cm) (15.8x15.8 in)
Scatter cushions

SOFÁ 2 SOFA 2

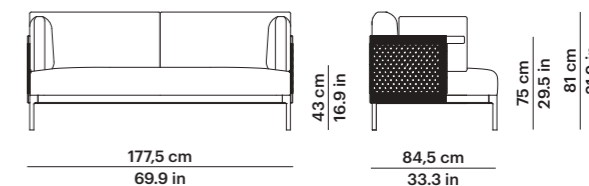

Ref. 79447

Peso Weight 57,4 Kg 126.5 lb
m³ 1,4 m³
Cuadrantes 2 (40x40 cm) (15.8x15.8 in)
Scatter cushions

SOFÁ 3 SOFA 3

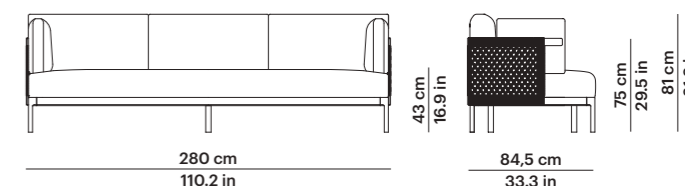

Ref. 79449

Peso Weight 85,4 Kg 188.3 lb
m³ 2,3 m³
Cuadrantes 5 (40x40 cm) (15.8x15.8 in)
Scatter cushions

Materiales y acabados Materials and finishes

Estructura Frame
Aluminio pintado en polvo
Powder coated aluminum
Cuerda Ø4 mm Rope Ø4 mm



Blanco Mineral 34
Mineral White 34

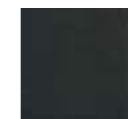

Gris Metalizado 56
Gunmetal Grey 56



Blanco Mineral 34
Mineral White 34
Beige



Gris Metalizado 56
Gunmetal Grey 56
Grafito
Graphite

LEGACY

MESA RINCÓN CUADRADA SQUARE SIDE TABLE

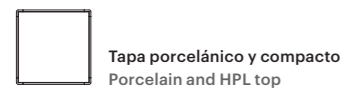
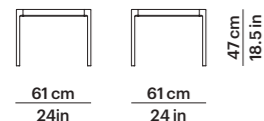

Ref. 79356

Peso Weight 15 Kg con tapa aluminio
33.1 lb with aluminum top
21,8 Kg con tapa porcelánico
48.1 lb with porcelain top
16,8 Kg con tapa compacto
37.1 lb with HPL top
m³ 0,24 m³

MESA CENTRO CUADRADA SQUARE COFFEE TABLE

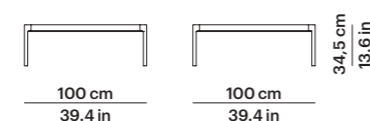

Ref. 79353

Peso Weight 26,2 Kg con tapa aluminio
57.8 lb with aluminum top
45,9 Kg con tapa porcelánico
101.1 lb with porcelain top
31,9 Kg con tapa compacto
70.2 lb with HPL top
m³ 0,46 m³

MESA CENTRO RECTANGULAR RECTANGULAR COFFEE TABLE

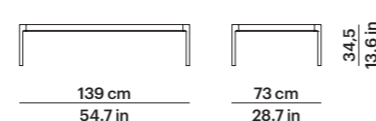

Ref. 79354

Peso Weight 25,4 Kg con tapa tecla
56 lb with aluminum top
43,5 Kg con tapa porcelánico
96 lb with porcelain top
29,9 Kg con tapa compacto
66.1 lb with HPL top
m³ 0,46 m³

Materiales y acabados Materials and finishes

Estructura
Frame

Aluminio pintado en polvo
Powder coated aluminum

Tapa Top
Compacto HPL

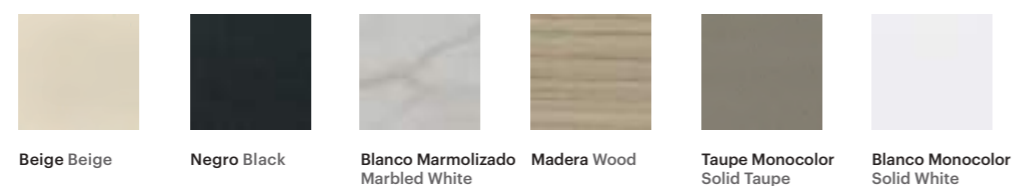

Tapa Top
Porcelánico Porcelain

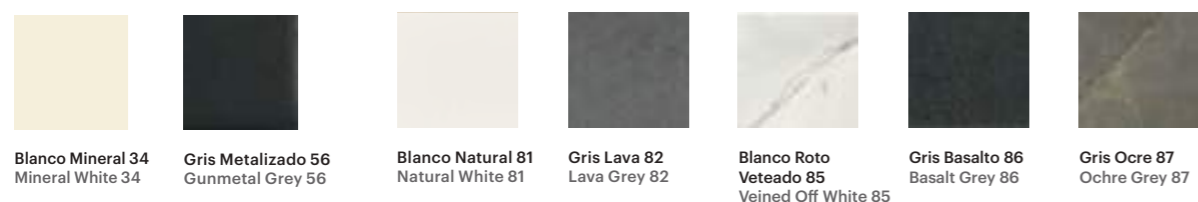

LIS

PIE MESA TABLE BASE

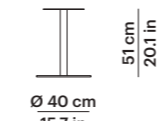

Ref. 78253

Peso Weight 12,8 Kg 28,2 lb
m³ 0,12 m³
Medida tapa Top size Ø 50 - Ø 60 cm
Ø 19.6 - Ø 23.6 In

PIE MESA TABLE BASE

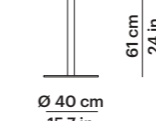

Ref. 78254

Peso Weight 13 Kg 28,7 lb
m³ 0,14 m³
Medida tapa Top size Ø 50 - Ø 60 cm
Ø 19.6 - Ø 23.6 In

Materiales y acabados Materials and finishes

Estructura Frame
Aluminio pintado en polvo
Powder coated aluminum

Acabados Finishes

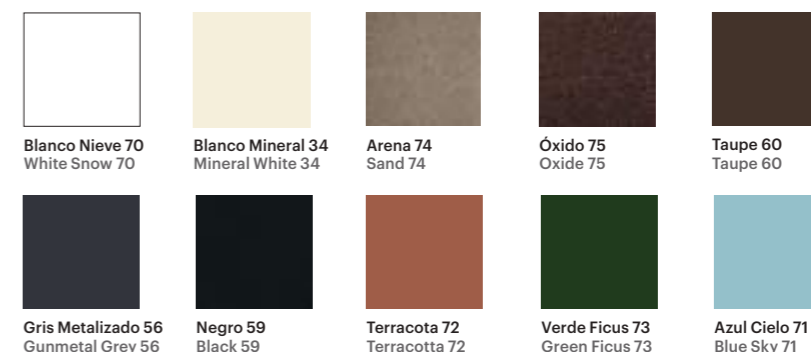

LONG ISLAND

SILLÓN LOUNGE CHAIR

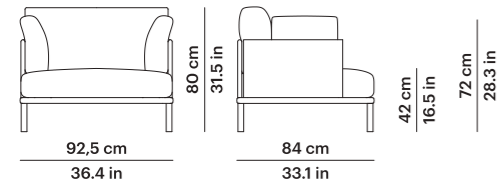

Ref. 77845

Peso Weight 29 Kg 63.9 lb
 m³ 0,63 m³
 Cuadrantes Scatter cushions 1 (55x30 cm) (21.6x11.8 in)

SOFÁ 2 SOFA 2

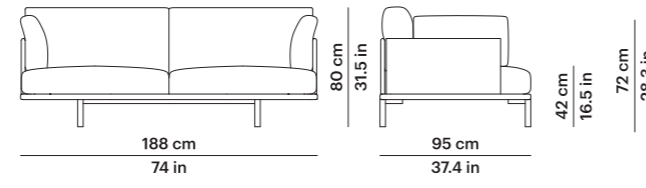

Ref. 77847

Peso Weight 52,2 Kg 115.1 lb
 m³ 1,35 m³
 Cuadrantes Scatter cushions 1 (60x35 cm) (23.6x13.7 in)
 2 (40x40 cm) (15.8x15.8 in)
 1 (50x50 cm) (19.7x19.7 in)

SOFÁ 3 SOFA 3

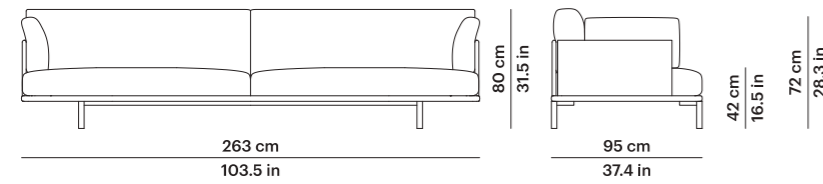

Ref. 77849

Peso Weight 83,2 Kg 183.4 lb
 m³ 1,86 m³
 Cuadrantes Scatter cushions 1 (60x35 cm) (23.6x13.7 in)
 2 (40x40 cm) (15.8x15.8 in)
 1 (50x50 cm) (19.7x19.7 in)
 1 (60x60 cm) (23.6x23.6 in)

PUF OTTOMAN

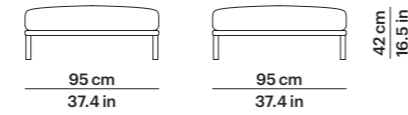

Ref. 77852

Peso Weight 23,8 Kg 52.5 lb
 m³ 0,49 m³

Materiales y acabados Materials and finishes

Estructura Frame
 Aluminio pintado en polvo
 Powder coated aluminum



Gris Metalizado 56
 Gunmetal Grey 56



Blanco Mineral 34
 Mineral White 34

LONG ISLAND

SOFÁ 2 MOD. BRAZO DCHO. RIGHT ARM SECTIONAL SOFA 2

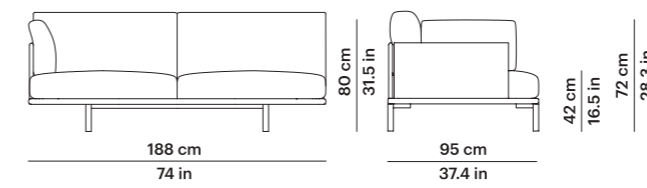

Ref. 77840

Peso Weight 49,8 Kg 109.8 lb
 m³ 1,35 m³
 Cuadrantes Scatter cushions 1 (60x35 cm) (23.6x13.7 in)
 1 (40x40 cm) (15.8x15.8 in)

SOFÁ 2 MOD. BRAZO IZQDO. LEFT ARM SECTIONAL SOFA 2

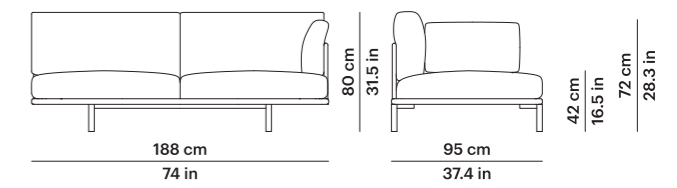

Ref. 77841

Peso Weight 49,8 Kg 109.8 lb
 m³ 1,35 m³
 Cuadrantes Scatter cushions 1 (60x35 cm) (23.6x13.7 in)
 1 (40x40 cm) (15.8x15.8 in)

SOFÁ 2 MOD. SIN BRAZOS ARMLESS SECTIONAL SOFA 2

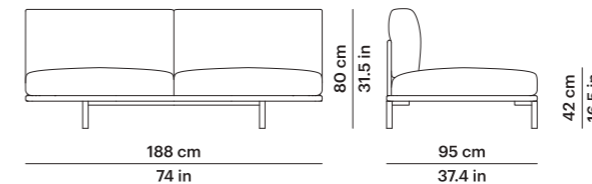

Ref. 77846

Peso Weight 47,4 Kg 104.5 lb
 m³ 1,35 m³
 Cuadrantes Scatter cushions 1 (60x35 cm) (23.6x13.7 in)
 1 (40x40 cm) (15.8x15.8 in)

Materiales y acabados Materials and finishes

Estructura Frame
 Aluminio pintado en polvo
 Powder coated aluminum



Gris Metalizado 56
 Gunmetal Grey 56



Blanco Mineral 34
 Mineral White 34

LONG ISLAND

SOFÁ 3 MOD. BRAZO DCHO. RIGHT ARM SECTIONAL SOFA 3

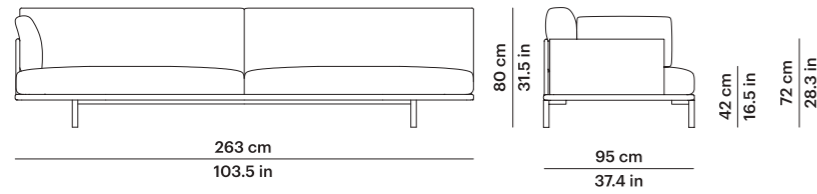

Ref. 77842

Peso Weight 80,8 Kg 178.1 lb
 m³ 1,86 m³
 Cuadrantes Scatter cushions
 1 (60x35 cm) (23.6x13.7 in)
 1 (40x40 cm) (15.8x15.8 in)
 1 (50x50 cm) (19.7x19.7 in)



SOFÁ 3 MOD. BRAZO IZQDO. LEFT ARM SECTIONAL SOFA 3

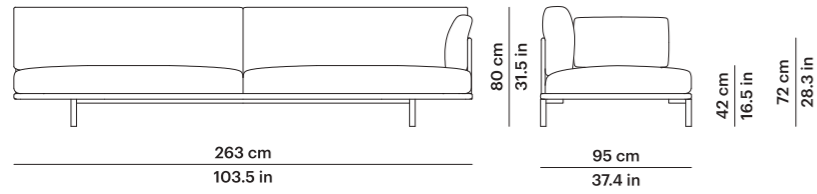

Ref. 77843

Peso Weight 80,8 Kg 178.1 lb
 m³ 1,86 m³
 Cuadrantes Scatter cushions
 1 (60x35 cm) (23.6x13.7 in)
 1 (40x40 cm) (15.8x15.8 in)
 1 (50x50 cm) (19.7x19.7 in)



Materiales y acabados Materials and finishes

Estructura Frame
 Aluminio pintado en polvo
 Powder coated aluminum



Gris Metalizado 56
 Gunmetal Grey 56

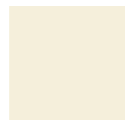

Blanco Mineral 34
 Mineral White 34

LONG ISLAND

SOFÁ 3 MOD. SIN BRAZOS ARMLESS SECTIONAL SOFA 3

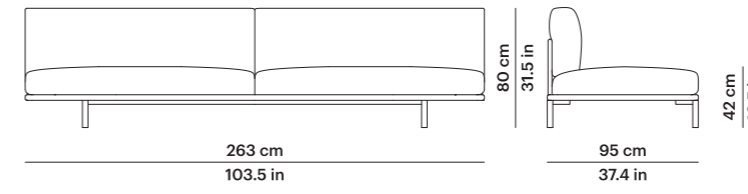

Ref. 77848

Peso Weight 78,4 Kg 172.8 lb
 m³ 1,86 m³
 Cuadrantes Scatter cushions
 1 (60x35 cm) (23.6x13.7 in)
 1 (40x40 cm) (15.8x15.8 in)
 1 (50x50 cm) (19.7x19.7 in)



RINCONERA CORNER

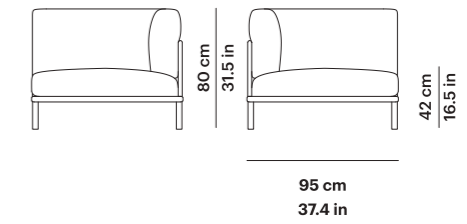

Ref. 77844

Peso Weight 30 Kg 66.1 lb
 m³ 0,72 m³



CHAISE LONGUE BRAZO DCHO. CHAISE LONGUE RIGHT ARM

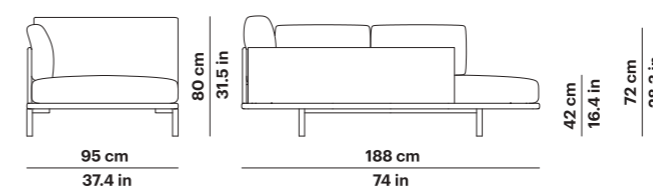

Ref. 77896

Peso Weight 48,8 Kg 107.6 lb
 m³ 1,35 m³
 Cuadrantes Scatter cushions
 1 (50x50 cm) (19.7x19.7 in)
 1 (60x60 cm) (23.6x23.6 in)



CHAISE LONGUE BRAZO IZQDO. CHAISE LONGUE LEFT ARM

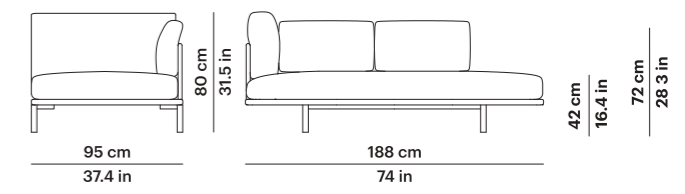

Ref. 77897

Peso Weight 48,8 Kg 107.6 lb
 m³ 1,35 m³
 Cuadrantes Scatter cushions
 1 (50x50 cm) (19.7x19.7 in)
 1 (60x60 cm) (23.6x23.6 in)



Materiales y acabados Materials and finishes

Estructura Frame
 Aluminio pintado en polvo
 Powder coated aluminum



Gris Metalizado 56
 Gunmetal Grey 56

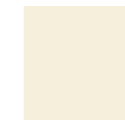

Blanco Mineral 34
 Mineral White 34

LONG ISLAND

MESA CENTRO CUADRADA SQUARE COFFEE TABLE

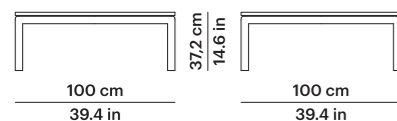

MESA CENTRO RECTANGULAR RECTANGULAR COFFEE TABLE

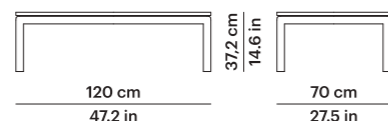

MESA RINCÓN CUADRADA SQUARE SIDE TABLE

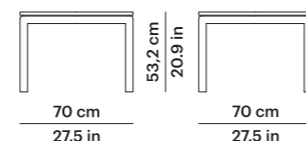

Ref. 77853

Peso Weight 43,4 Kg con tapa porcelánico
95.7 lb with porcelain top
25 Kg con tapa compacto
55.1 lb with HPL top

m³ 0,46 m³

Ref. 77854

Peso Weight 39,9 Kg con tapa porcelánico
88 lb with porcelain top
25 Kg con tapa compacto
55.1 lb with HPL top

m³ 0,49 m³

Ref. 77856

Peso Weight 24,6 Kg con tapa porcelánico
54.2 lb with porcelain top
14,8 Kg con tapa compacto
32.6 lb with HPL top

m³ 0,4 m³

Materiales y acabados Materials and finishes

Estructura Frame
Aluminio pintado en polvo
Powder coated aluminum



Gris Metalizado 56
Gunmetal Grey 56

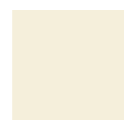

Blanco Mineral 34
Mineral White 34

Tapa Top
Compacto HPL



Beige Beige



Negro Black

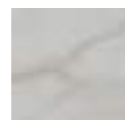

Blanco Marmolizado
Marbled White



Madera Wood



Taupe Monocolor
Solid Taupe

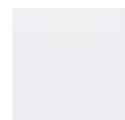

Blanco Monocolor
Solid White

Tapa Top
Porcelánico Porcelain

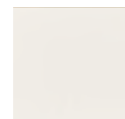

Blanco Natural 81
Natural White 81



Gris Lava 82
Lava Grey 82



Blanco Roto
Veteado 85
Veined Off White 85

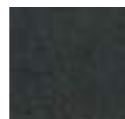

Gris Basalto 86
Basalt Grey 86

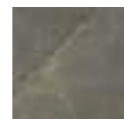

Gris Ocre 87
Ochre Grey 87

NECK

PIE MESA TABLE BASE

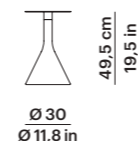

Ref. 79758

Peso Weight 21 Kg 46.3 lb
m³ 0,13
Medida tapa
Top size Ø 50 - Ø 60 cm
Ø 19.6 - Ø 23.6 in

PIE MESA TABLE BASE

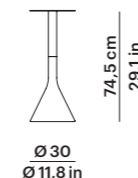

Ref. 79715

Peso Weight 23 Kg 57.7 lb
m³ 0,18
Medida tapa
Top size Ø 70 - Ø 80 - Ø 90 cm
Ø 27.6 - Ø 31.5 - Ø 35.4 in
27.6x27.6 - 31.5x31.5 - 35.4x35.4

PIE MESA DOBLE DOUBLE TABLE BASE

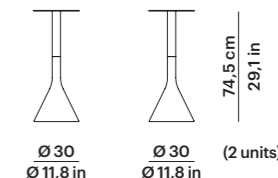

Ref. 79709

Peso Weight 46 Kg 101.4 lb
m³ 0,36
Medida tapa
Top size 160x90 cm
63x35.4 in

Materiales y acabados Materials and finishes

Estructura Frame
Aluminio pintado en polvo
Powder coated aluminum



Gris Metalizado 56
Gunmetal Grey 56



Blanco Mineral 34
Mineral White 34

Base Base

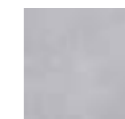

Hormigón
Concrete

ORIGIN

SILLA SIDE CHAIR

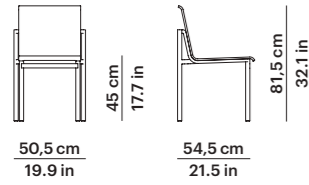

Ref. 79101

Peso Weight 8,9 Kg 19.6 lb (1 pc)
25,6 Kg 56.4 lb (4 pcs)
m³ 0,30 m³ (1 pc)
0,46 m³ (4 pcs)



SILLÓN COMEDOR ARMCHAIR

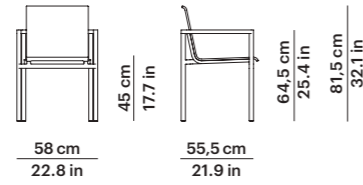

Ref. 79106

Peso Weight 10,3 Kg 22.7 lb (1 pc)
31,2 Kg 68.8 lb (4 pcs)
m³ 0,34 m³ (1 pc)
0,52 m³ (4 pcs)



SILLÓN LOUNGE CHAIR

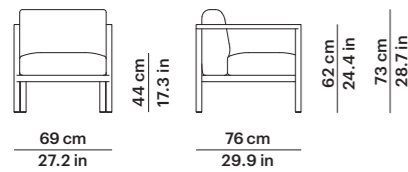

Ref. 79145

Peso Weight 17,3 Kg 38.1 lb
m³ 0,49 m³
Cuadrantes 1 (55x23 cm)
Scatter cushions 1 (21.7x9.1 in)

TABURETE BAR BAR STOOL

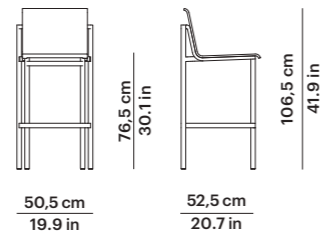

Ref. 79152

Peso Weight 9,7 Kg 21.4 lb (1 pc)
15,4 Kg 34 lb (2 pcs)
m³ 0,40 m³ (1 pc)
0,40 m³ (2 pcs)



Materiales y acabados Materials and finishes

Estructura
Frame
Aluminio pintado en polvo
Powder coated aluminum

Acabados Estructuras Frame Finishes



Blanco Mineral 34
Mineral White 34



Gris Metalizado 56
Gunmetal
Grey 56

Acabados Telas Fabric Finishes



Batyline 35



Batyline 57

ORIGIN

SOFÁ 2 MODULAR BRAZO DERECHO RIGHT ARM SECTIONAL SOFA 2

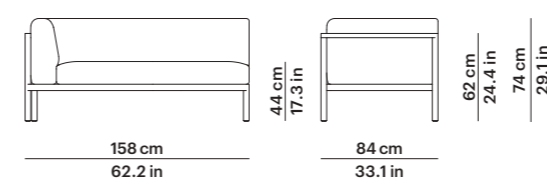

Ref. 79144

Peso Weight 32,8 Kg 72.3 lb
m³ 1,18 m³
Cuadrantes 2 (40x40 cm)
Scatter cushions 2 (15.8x15.8 in)

SOFÁ 2 MODULAR BRAZO IZQUIERDO LEFT ARM SECTIONAL SOFA 2

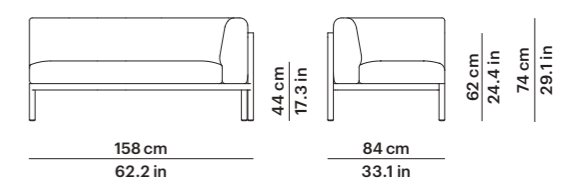

Ref. 79146

Peso Weight 32,8 Kg 72.3 lb
m³ 1,18 m³
Cuadrantes 2 (40x40 cm)
Scatter cushions 2 (15.8x15.8 in)

SOFÁ 2 SOFA 2

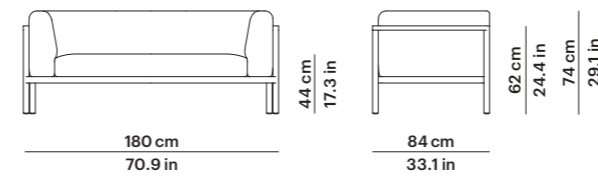

Ref. 79147

Peso Weight 39 Kg 86 lb
m³ 1,34 m³
Cuadrantes 4 (40x40 cm)
Scatter cushions 4 (15.8x15.8 in)

TUMBONA CHAISE

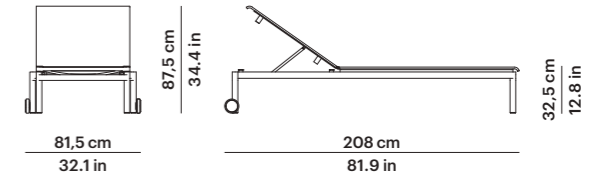

Ref. 79195

Peso Weight 23,8 Kg 52.5 lb (1 pc)
41 Kg 90.4 lb (2 pcs)
m³ 0,66 m³ (1 pc)
0,66 m³ (2 pcs)



Materiales y acabados Materials and finishes

Estructura
Frame
Aluminio pintado en polvo
Powder coated aluminum

Acabados Estructuras Frame Finishes



Blanco Mineral 34
Mineral White 34



Gris Metalizado 56
Gunmetal
Grey 56

Acabados Telas Fabric Finishes



Batyline 35



Batyline 57

ORIGIN

SOFÁ 3 MODULAR BRAZO DERECHO RIGHT ARM SECTIONAL SOFA 3

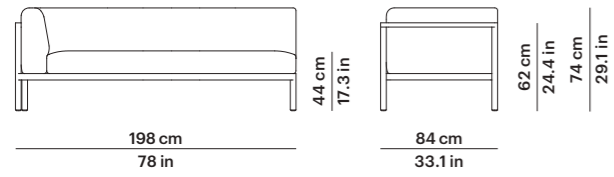

Ref. 79142

Peso Weight 45,6 Kg 100.5 lb
 m³ 1,47 m³
 Cuadrantes 3 (40x40 cm)
 Scatter cushions 3 (15.8x15.8 in)

SOFÁ 3 MODULAR BRAZO IZQUIERDO LEFT ARM SECTIONAL SOFA 3

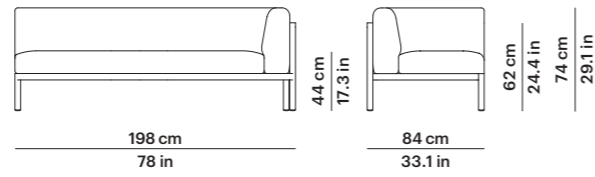

Ref. 79143

Peso Weight 45,6 Kg 100.5 lb
 m³ 1,47 m³
 Cuadrantes 3 (40x40 cm)
 Scatter cushions 3 (15.8x15.8 in)

SOFÁ 3 SOFA 3

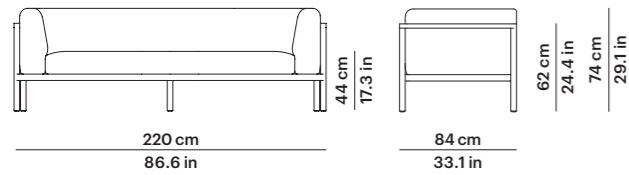

Ref. 79149

Peso Weight 46,8 Kg 103.2 lb
 m³ 1,63 m³
 Cuadrantes 5 (40x40 cm)
 Scatter cushions 5 (15.8x15.8 in)

Materiales y acabados Materials and finishes

Estructura
 Frame
 Aluminio pintado en polvo
 Powder coated aluminum

Acabados Estructuras Frame Finishes



ORIGIN

MESA AUXILIAR SIDE TABLE

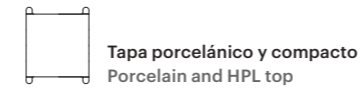
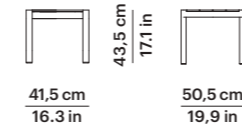

Ref. 79158

Peso Weight 16,6 Kg con tapa aluminio
 36.6 lb with aluminum top
 19 Kg con tapa porcelánico
 41.9 lb with porcelain top
 16,4 Kg con tapa compacto
 36.2 lb with HPL top
 m³ 0,10 m³

MESA CENTRO CUADRADA SQUARE COFFEE TABLE

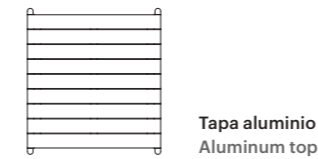
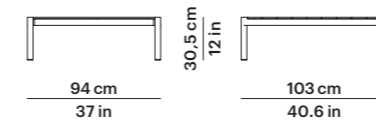

Ref. 79153

Peso Weight 22,8 Kg con tapa aluminio
 50.3 lb with aluminum top
 42,2 Kg con tapa porcelánico
 93.1 lb with porcelain top
 29 Kg con tapa compacto
 63.9 lb with HPL top
 m³ 0,40 m³

MESA RINCÓN CUADRADA SQUARE SIDE TABLE

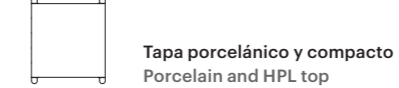
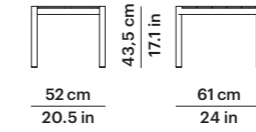

Ref. 79156

Peso Weight 9,2 Kg con tapa aluminio
 20.3 lb with aluminum top
 15,3 Kg con tapa porcelánico
 33.8 lb with porcelain top
 11,3 Kg con tapa compacto
 24.9 lb with HPL top
 m³ 0,19 m³

MESA CENTRO RECTANGULAR RECTANGULAR COFFEE TABLE

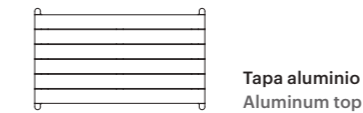
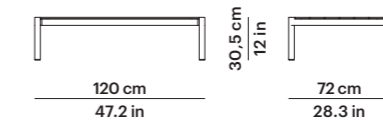

Ref. 79154

Peso Weight 17 Kg con tapa aluminio
 37.5 lb with aluminum top
 33,6 Kg con tapa porcelánico
 74 lb with porcelain top
 22,3 Kg con tapa compacto
 49.2 lb with HPL top
 m³ 0,36 m³

ORIGIN

MESA COMEDOR CUADRADA SQUARE DINING TABLE

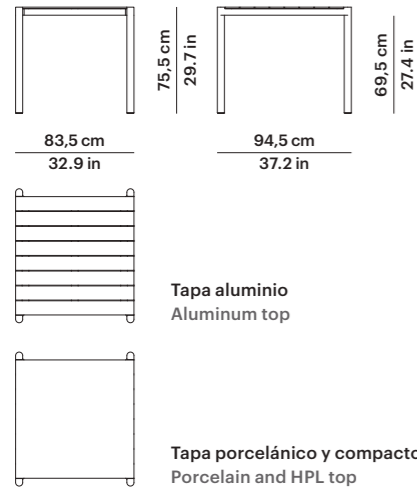

Ref. 79110

Peso Weight 21,2 Kg con tapa aluminio
46.7 lb with aluminum top
36,6 Kg con tapa porcelánico
80.7 lb with porcelain top
26,2 Kg con tapa compacto
57.7 lb with HPL top
m³ 0,73 m³

MESA COMEDOR RECTANGULAR RECTANGULAR DINING TABLE

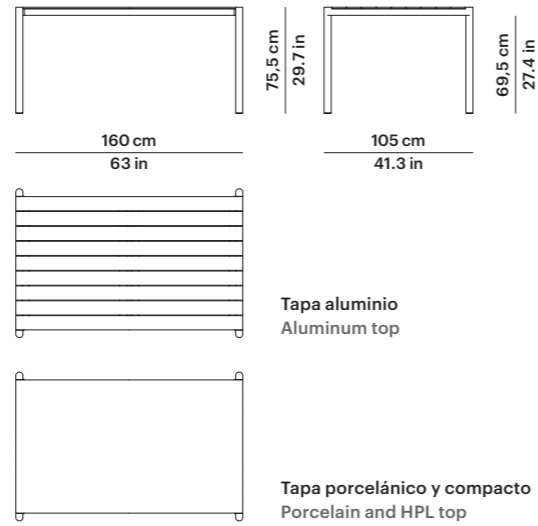

Ref. 79109

Peso Weight 33,4 Kg con tapa aluminio
73.6 lb with aluminum top
66,4 Kg con tapa porcelánico
146.4 lb with porcelain top
43,9 Kg con tapa compacto
96.7 lb with HPL top
m³ 1,5 m³

Materiales y acabados Materials and finishes

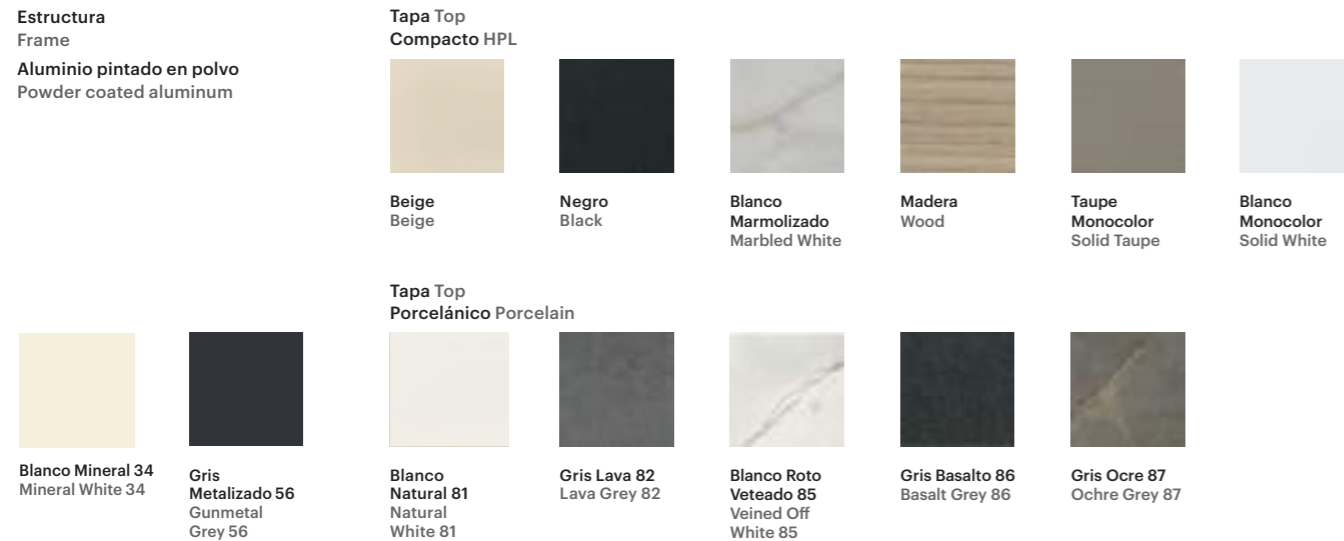

ORIGIN

MESA COMEDOR RECTANGULAR RECTANGULAR DINING TABLE

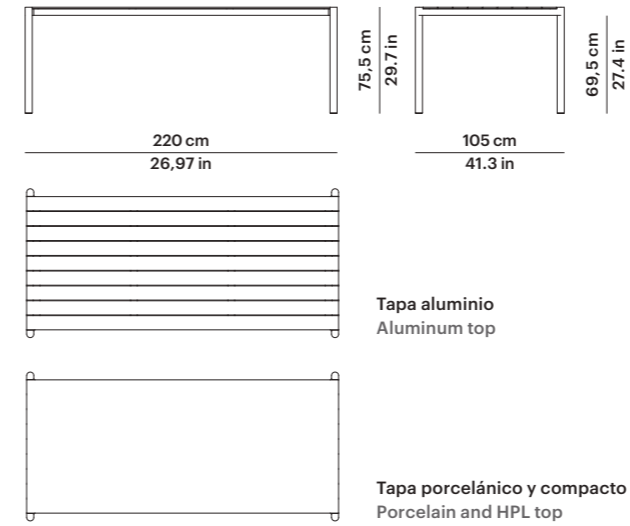

Ref. 79108

Peso Weight 46,4 Kg con tapa aluminio
102.3 lb with aluminum top
93,2 Kg con tapa porcelánico
205.4 lb with porcelain top
62,2 Kg con tapa compacto
137 lb with HPL top
m³ 2,04 m³

Materiales y acabados Materials and finishes

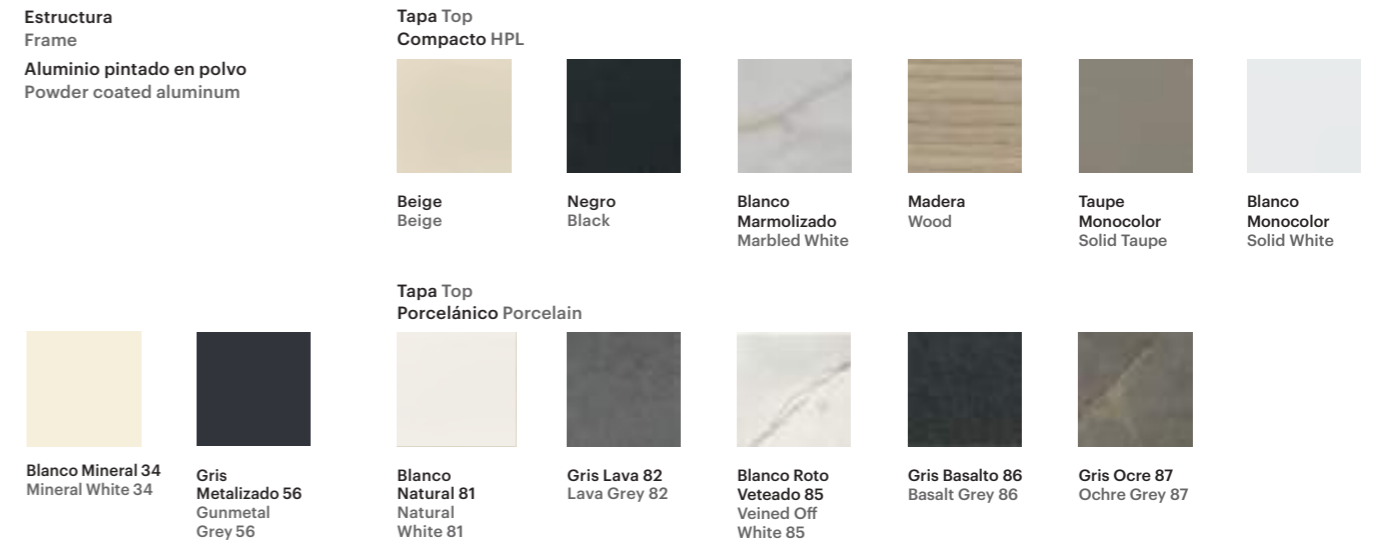

PUF OTTOMAN

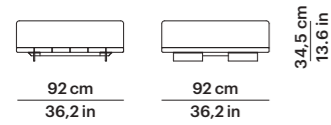

Ref. 7704400

Peso Weight 46 Kg 101.4 lb
m³ 0,39 m³

MÓDULO CENTRO CENTRAL MODULE

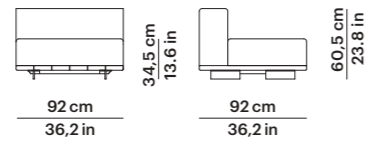

Ref. 7704500

Peso Weight 52 Kg 114.6 lb
m³ 0,64 m³

SOFA 2 SOFA 2

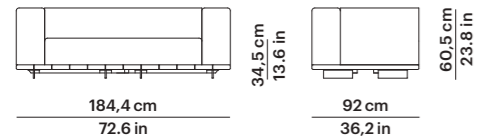

Ref. 7704700

Peso Weight 107,5 Kg 237 lb
m³ 1,24 m³
Cuadrantes Scatter cushions 2 (50x50 cm) (19.7x19.7 in)

SOFA 3 SOFA 3

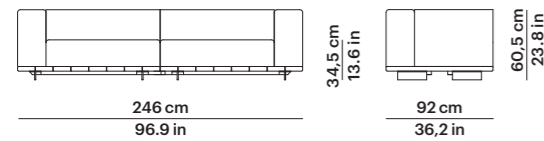

Ref. 7704900

Peso Weight 142,5 Kg 314.2 lb
m³ 1,64 m³
Cuadrantes Scatter cushions 2 (50x50 cm) (19.7x19.7 in)

Materiales y acabados Materials and finishes

Estructura Frame
Teca natural
Natural teak
Patas Legs
Aluminio pintado en polvo
Powder coated aluminum

Acabado estructura Frame finish



Teca Natural
Natural Teak

Acabado patas Legs finish



Gris Metalizado 56
Gunmetal Grey 56

BASE 92X92 + ASIENTO SINGLE SINGLE SEAT

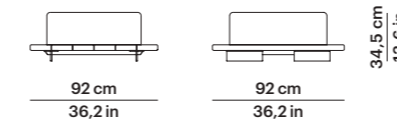

Ref. 7704505

Peso Weight 41,5 Kg 91 lb
m³ 0,64 m³

BASE 92X92 + ASIENTO SINGLE + RESP.SINGLE + BRAZO DERECHO SINGLE SEAT & BACK + RIGHT ARM

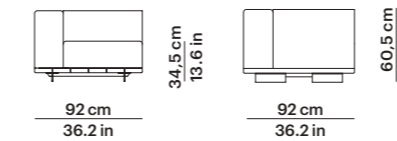

Ref. 7704504

Peso Weight 55,5 Kg 122 lb
m³ 0,64 m³

BASE 184X92 + ASIENTO SINGLE + RESP. SINGLE + BRAZO IZQUIERDO SINGLE SEAT & BACK + LEFT ARM

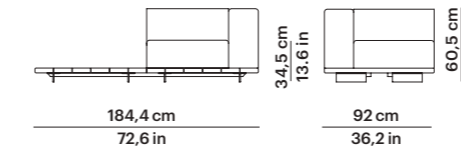

Ref. 7704705

Peso Weight 88 Kg 194 lb
m³ 0,84 m³

BASE 92X92 + ASIENTO SINGLE + RESP. SINGLE IZQUIERDO LEFT SINGLE SEAT & BACK

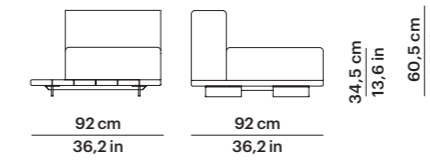

Ref. 7704502

Peso Weight 48,5 Kg 106 lb
m³ 0,64 m³

BASE 92X92 + ASIENTO SINGLE + RESP.SINGLE + BRAZO IZQUIERDO SINGLE SEAT & BACK + LEFT ARM

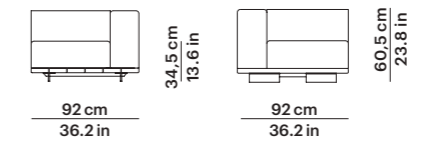

Ref. 7704503

Peso Weight 55,5 Kg 122 lb
m³ 0,64 m³

BASE 184X92 + ASIENTO SINGLE + RESP. DOBLE DERECHA RIGHT DOUBLE SEAT & BACK

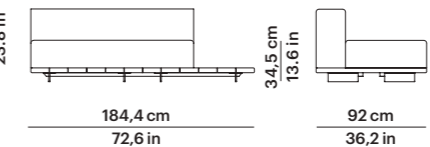

Ref. 7704701

Peso Weight 93,5 Kg 206 lb
m³ 1,26 m³
Cuadrantes Scatter cushions 1 (50x50 cm) (19.7x19.7 in)

BASE 92X92 + ASIENTO SINGLE + RESP. SINGLE DERECHO RIGHT SINGLE SEAT & BACK

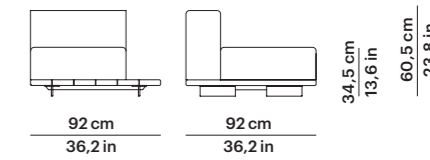

Ref. 7704501

Peso Weight 48,5 Kg 106 lb
m³ 0,64 m³

BASE 184X92 + ASIENTO SINGLE + RESP. SINGLE + BRAZO DERECHO SINGLE SEAT & BACK + RIGHT ARM

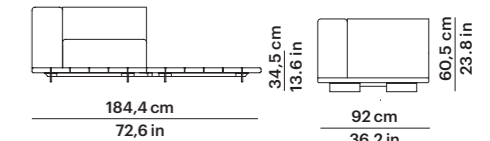

Ref. 7704706

Peso Weight 88 Kg 194 lb
m³ 0,84 m³

BASE 184X92 + ASIENTO SINGLE + RESP. DOBLE IZQUIERDA LEFT DOUBLE SEAT & BACK

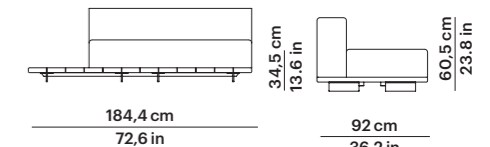

Ref. 7704702

Peso Weight 93,5 Kg 206 lb
m³ 1,26 m³
Cuadrantes Scatter cushions 1 (50x50 cm) (19.7x19.7 in)

Materiales y acabados Materials and finishes

Estructura Frame
Teca natural
Natural teak
Patas Legs
Aluminio pintado en polvo
Powder coated aluminum

Acabado estructura Frame finish



Teca Natural
Natural Teak

Acabado patas Legs finish



Gris Metalizado 56
Gunmetal Grey 56

PAL

BASE 184X92 + ASIENTO DOBLE + RESP.DOUBLE CENTRO CENTER SEAT & BACK

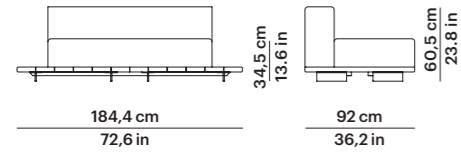

Ref. 7704709

Peso Weight 90,5 Kg 199 lb
 m³ 1,26 m³
 Cuadrantes 1 (50x50 cm) (19.7x19.7 in)
 Scatter cushions

BASE 184X92 + ASIENTO DOBLE + RESP. DOBLE + BRAZO IZQUIERDO DOUBLE SEAT & BACK + LEFT ARM

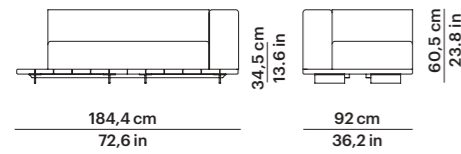

Ref. 7704707

Peso Weight 100,5 Kg 221 lb
 m³ 1,26 m³
 Cuadrantes 1 (50x50 cm) (19.7x19.7 in)
 Scatter cushions

BASE 184X92 + ASIENTO Y RESP. DOBLE + BRAZO IZQ. A LA DERECHA DOUBLE SEAT & BACK + LEFT ARM TO RIGHT

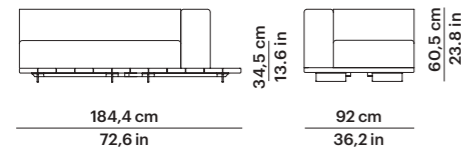

Ref. 7704710

Peso Weight 100,5 Kg 221 lb
 m³ 1,26 m³
 Cuadrantes 1 (50x50 cm) (19.7x19.7 in)
 Scatter cushions

BASE 184X92 + ASIENTO DOBLE + RESP. SINGLE + BRAZO IZQUIERDO DOUBLE SEAT + SINGLE BACK + LEFT ARM

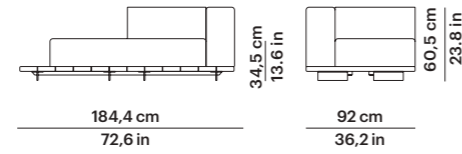

Ref. 7704703

Peso Weight 93,5 Kg 206 lb
 m³ 1,26 m³
 Cuadrantes 1 (50x50 cm) (19.7x19.7 in)
 Scatter cushions

BASE 184X92 + ASIENTO DOBLE + RESP. DOBLE + BRAZO DERECHO DOUBLE SEAT & BACK + RIGHT ARM

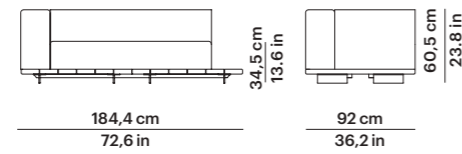

Ref. 7704708

Peso Weight 100,5 Kg 221 lb
 m³ 1,26 m³
 Cuadrantes 1 (50x50 cm) (19.7x19.7 in)
 Scatter cushions

BASE 184X92 + ASIENTO Y RESP. DOBLE + BRAZO DER. A LA IZQUIERDA DOUBLE SEAT & BACK + RIGHT ARM TO LEFT

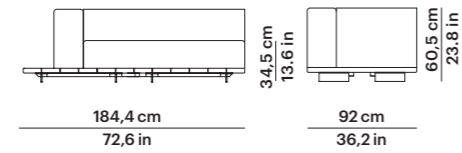

Ref. 7704711

Peso Weight 100,5 Kg 221 lb
 m³ 1,26 m³
 Cuadrantes 1 (50x50 cm) (19.7x19.7 in)
 Scatter cushions

BASE 184X92 + ASIENTO DOBLE + RESP.SINGLE + BRAZO DERECHO DOUBLE SEAT + SINGLE BACK + RIGHT ARM

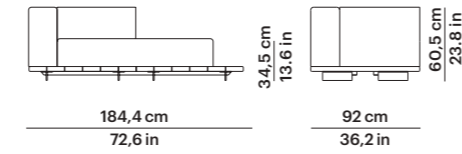

Ref. 7704704

Peso Weight 93,5 Kg 206 lb
 m³ 1,26 m³
 Cuadrantes 1 (50x50 cm) (19.7x19.7 in)
 Scatter cushions

PAL

BASE 246X92 + ASIENTO DOBLE + RESP. DOBLE IZQUIERDO LEFT DOUBLE SEAT & BACK

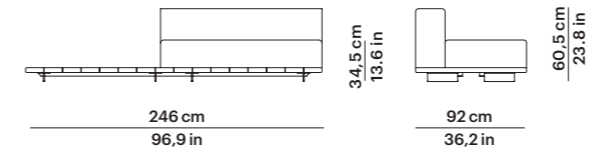

Ref. 7704902

Peso Weight 111,5 Kg 245 lb
 m³ 1,38 m³
 Cuadrantes Scatter cushions 1 (50x50 cm) (19.7x19.7 in)

BASE 246X92 + ASIENTO DOBLE + RESP. DOBLE + BRAZO IZQUIERDO DOUBLE SEAT & BACK + LEFT ARM

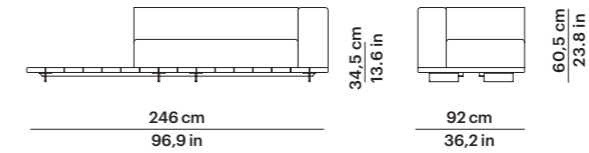

Ref. 7704904

Peso Weight 118,5 Kg 261 lb
 m³ 1,38 m³
 Cuadrantes Scatter cushions 1 (50x50 cm) (19.7x19.7 in)

BASE 246X92 + ASIENTO Y RESPALDO DOBLE + ASIENTO Y RESPALDO SINGLE IZQUIERDO LEFT DOUBLE SEAT & BACK + SINGLE SEAT & BACK

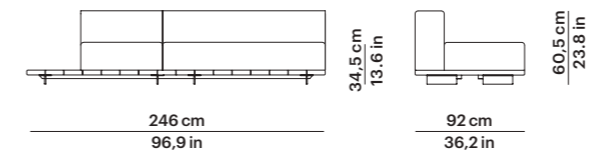

Ref. 7704907

Peso Weight 128,5 Kg 283 lb
 m³ 1,84 m³
 Cuadrantes Scatter cushions 1 (50x50 cm) (19.7x19.7 in)

BASE 246X92 + ASIENTO DOBLE + RESP. DOBLE DERECHO RIGHT DOUBLE SEAT & BACK

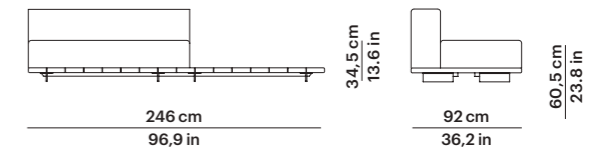

Ref. 7704901

Peso Weight 111,5 Kg 245 lb
 m³ 1,38 m³
 Cuadrantes Scatter cushions 1 (50x50 cm) (19.7x19.7 in)

BASE 246X92 + ASIENTO DOBLE + RESP. DOBLE + BRAZO DERECHO DOUBLE SEAT & BACK + RIGHT ARM

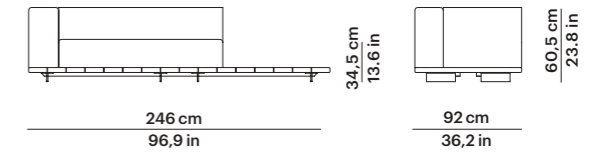

Ref. 7704903

Peso Weight 118,5 Kg 261 lb
 m³ 1,38 m³
 Cuadrantes Scatter cushions 1 (50x50 cm) (19.7x19.7 in)

BASE 246X92 + ASIENTO Y RESPALDO DOBLE + ASIENTO Y RESPALDO SINGLE DERECHO RIGHT DOUBLE SEAT & BACK + SINGLE SEAT & BACK

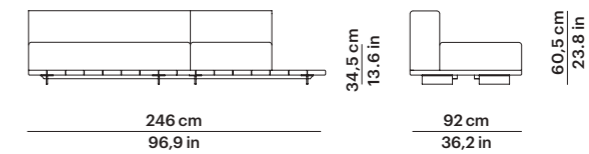

Ref. 7704908

Peso Weight 128,5 Kg 283 lb
 m³ 1,84 m³
 Cuadrantes Scatter cushions 1 (50x50 cm) (19.7x19.7 in)

Materiales y acabados Materials and finishes

Estructura Frame
 Teca natural
 Natural teak
 Patas Legs
 Aluminio pintado en polvo
 Powder coated aluminum

Acabado estructura Frame finish



Teca Natural
 Natural Teak

Acabado patas Legs finish



Gris Metalizado 56
 Gunmetal Grey 56

PAL

BASE 246X92 + ASIENTO Y RESPALDO DOBLE + ASIENTO SINGLE + BRAZO IZQUIERDO DOUBLE SEAT & BACK + SINGLE SEAT + LEFT ARM

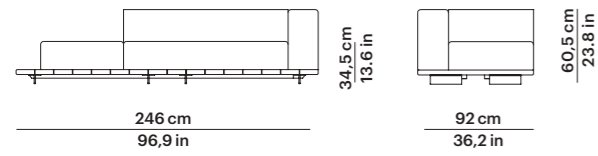

Ref. 7704909

Peso Weight	128,5 Kg 283 lb
m ³	1,84 m ³
Cuadrantes Scatter cushions	1 (50x50 cm) (19.7x19.7 in)

BASE 246X92 + ASIENTO Y RESPALDO DOBLE + ASIENTO SINGLE + BRAZO DERECHO DOUBLE SEAT & BACK + SINGLE SEAT + RIGHT ARM

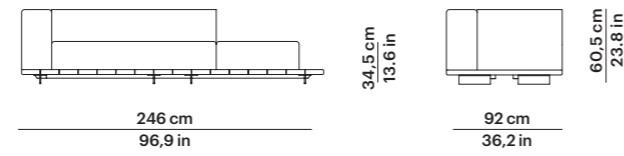

Ref. 7704910

Peso Weight	128,5 Kg 283 lb
m ³	1,84 m ³
Cuadrantes Scatter cushions	1 (50x50 cm) (19.7x19.7 in)

BASE 246X92 + ASIENTO Y RESP. DOBLE + ASIENTO Y RESP. SINGLE + BRAZO IZQUIERDO DOUBLE SEAT & BACK + SINGLE SEAT & BACK + LEFT ARM

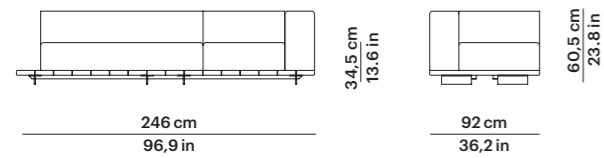

Ref. 7704905

Peso Weight	135,5 Kg 298 lb
m ³	1,84 m ³
Cuadrantes Scatter cushions	1 (50x50 cm) (19.7x19.7 in)

BASE 246X92 + ASIENTO DOBLE + RESP. DOBLE + BRAZO DERECHO DOUBLE SEAT & BACK + RIGHT ARM

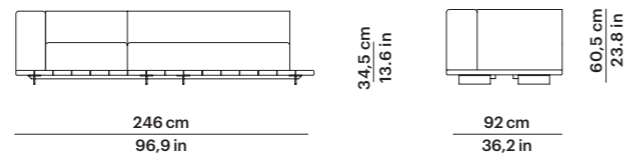

Ref. 7704906

Peso Weight	135,5 Kg 298 lb
m ³	1,84 m ³
Cuadrantes Scatter cushions	1 (50x50 cm) (19.7x19.7 in)

BASE 246X92 + SOFÁ 2 COMPLETO DERECHA RIGHT COMPLETE SOFA 2

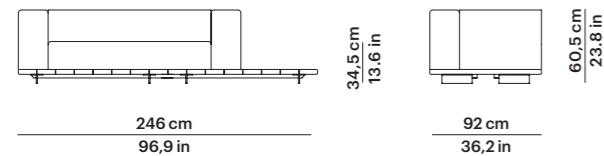

Ref. 7704911

Peso Weight	120 Kg 264 lb
m ³	1,35 m ³
Cuadrantes Scatter cushions	1 (50x50 cm) (19.7x19.7 in)

BASE 246X92 + SOFÁ 2 COMPLETO IZQUIERDA LEFT COMPLETE SOFA 2

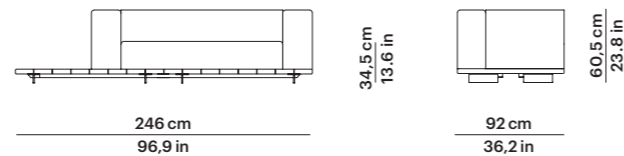

Ref. 7704912

Peso Weight	120 Kg 264 lb
m ³	1,35 m ³
Cuadrantes Scatter cushions	1 (50x50 cm) (19.7x19.7 in)

Materiales y acabados Materials and finishes

Estructura Frame

Teca natural
Natural teak

Patas Legs

Aluminio pintado en polvo
Powder coated aluminum

Acabado estructura Frame finish



Teca Natural
Natural Teak

Acabado patas Legs finish



Gris Metalizado 56
Gunmetal Grey 56

PAL

BASE 246X92 + ASIENTO Y RESPALDO SINGLE IZQUIERDA + ASIENTO DOBLE BASE 246X92 + RIGHT SINGLE SEAT & BACK + DOUBLE SEAT

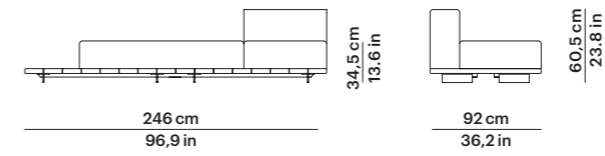

Ref. 7704913

Peso Weight	107 Kg 235 lb
m ³	1,35 m ³
Cuadrantes Scatter cushions	1 (50x50 cm) (19.7x19.7 in)

BASE 246X92 + ASIENTO Y RESP. DOBLE + ASIENTO Y RESP. SIMPLE + BRAZO IZQ. A LA DERECHA DOUBLE SEAT & BACK + SINGLE SEAT & BACK + LEFT ARM TO RIGHT

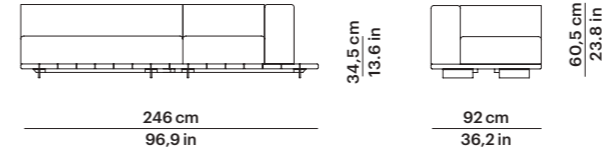

Ref. 7704915

Peso Weight	135,5 Kg 298 lb
m ³	1,35 m ³
Cuadrantes Scatter cushions	1 (50x50 cm) (19.7x19.7 in)

BASE 246X92 + ASIENTO Y RESPALDO DOBLE DERECHA + ASIENTO SINGLE RIGHT DOUBLE SEAT & BACK + SINGLE SEAT

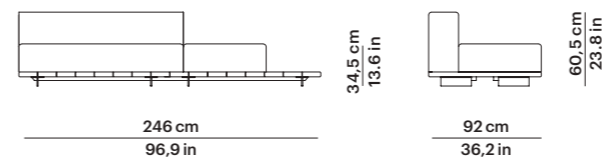

Ref. 7704917

Peso Weight	115 Kg 253 lb
m ³	1,35 m ³
Cuadrantes Scatter cushions	1 (50x50 cm) (19.7x19.7 in)

Materiales y acabados Materials and finishes

Estructura Frame

Teca natural
Natural teak

Patas Legs

Aluminio pintado en polvo
Powder coated aluminum

Acabado estructura Frame finish



Teca Natural
Natural Teak

Acabado patas Legs finish



Gris Metalizado 56
Gunmetal Grey 56

BASE 246X92 + ASIENTO Y RESPALDO SINGLE DERECHA + ASIENTO DOBLE BASE 246X92 + LEFT SINGLE SEAT & BACK + DOUBLE SEAT

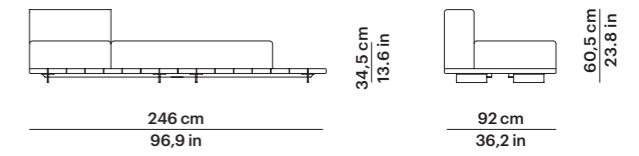

Ref. 7704914

Peso Weight	107 Kg 235 lb
m ³	1,35 m ³
Cuadrantes Scatter cushions	1 (50x50 cm) (19.7x19.7 in)

BASE 246X92 + ASIENTO Y RESP. DOBLE + ASIENTO Y RESP. SIMPLE + BRAZO DCHO. A LA IZQUIERDA DOUBLE SEAT & BACK + SINGLE SEAT & BACK + RIGHT ARM TO LEFT

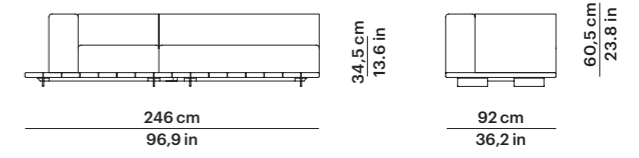

Ref. 7704916

Peso Weight	135,5 Kg 298 lb
m ³	1,35 m ³
Cuadrantes Scatter cushions	1 (50x50 cm) (19.7x19.7 in)

BASE 246X92 + ASIENTO Y RESPALDO DOBLE IZQUIERDA + ASIENTO SINGLE LEFT DOUBLE SEAT & BACK + SINGLE SEAT

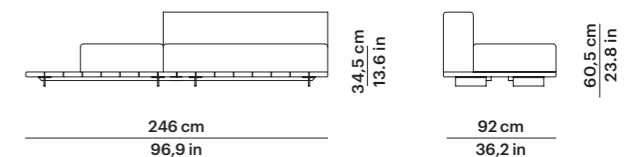

Ref. 7704918

Peso Weight	115 Kg 253 lb
m ³	1,35 m ³
Cuadrantes Scatter cushions	1 (50x50 cm) (19.7x19.7 in)

BASE 185X185 + ASIENTO TUMBONA SUNBED SEAT

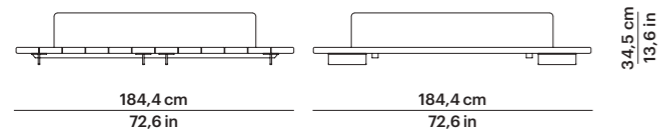

Ref. 7709502

Peso Weight 150,5 Kg 331 lb
m³ 2,1 m³

BASE 185X185 + ASIENTO TUMBONA + RESP. DOBLE + BRAZO IZQUIERDO SUNBED SEAT + DOUBLE BACK + LEFT ARM

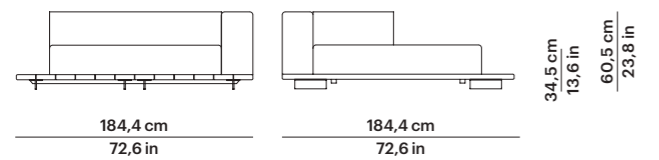

Ref. 7709503

Peso Weight 170,5 Kg 375 lb
m³ 2,1 m³

BASE 185X185 + 2 ASIENTO DOBLE + 2 RESPALDO SINGLE VIS A VIS 2 VIS A VIS DOUBLE SEAT + SINGLE BACK

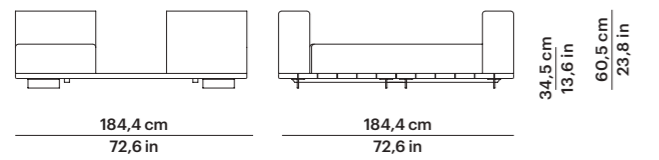

Ref. 7709505

Peso Weight 162 Kg 357 lb
m³ 2,5 m³

Materialos y acabados Materials and finishes

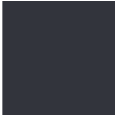
Estructura Frame Teca natural Natural teak	Acabado estructura Frame finish		Acabado patas Legs finish	
Patas Legs Aluminio pintado en polvo Powder coated aluminum		Teca Natural Natural Teak		Gris Metalizado 56 Gunmetal Grey 56

BASE 185X185 + ASIENTO TUMBONA + RESP. DOBLE SUNBED SEAT + DOUBLE BACK

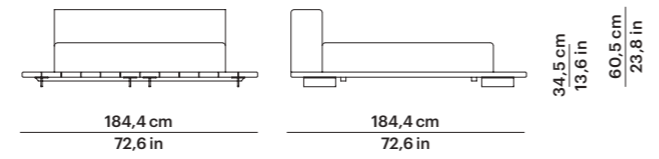

Ref. 7709501

Peso Weight 166,5 Kg 367 lb
m³ 2,1 m³

BASE 185X185 + ASIENTO TUMBONA + RESP. DOBLE + BRAZO DERECHO SUNBED SEAT + DOUBLE BACK + RIGHT ARM

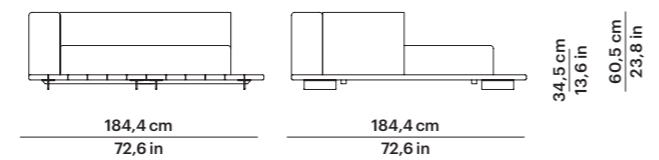

Ref. 7709504

Peso Weight 170,5 Kg 375 lb
m³ 2,1 m³

BASE 185X185 + ASIENTO DOBLE + 2 RESPALDO SINGLE PARALELOS 2 PARALLEL DOUBLE SEAT + 2 SINGLE BACK

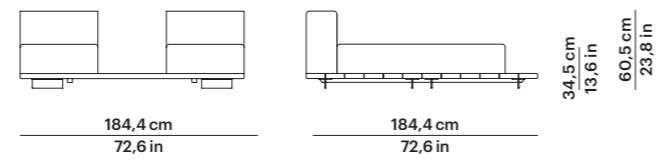

Ref. 7709506

Peso Weight 162 Kg 357 lb
m³ 2,5 m³

MESA REDONDA 28 ROUND TABLE 28

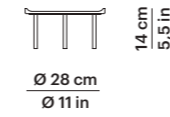

Ref. 77015

Peso Weight 4,3 Kg 9 lb
m³ 0,03 m³

MESA REDONDA 42 ROUND TABLE 42

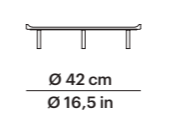

Ref. 77014

Peso Weight 7,2 Kg 15 lb
m³ 0,03 m³

MESA RECTANGULAR 50 MESA RECTANGULAR 65 RECTANGULAR TABLE 50 RECTANGULAR TABLE 65

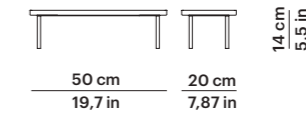

Ref. 77017

Peso Weight 5 Kg 11 lb
m³ 0,03 m³

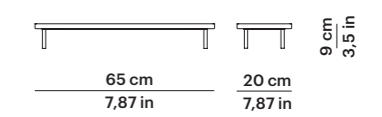

Ref. 77016

Peso Weight 6,8 Kg 14 lb
m³ 0,03 m³

Materialos y acabados Materials and finishes

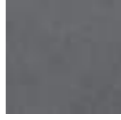
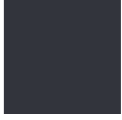
Tapa Top Granito Granite	Acabado tapa Top finish		Acabado patas Legs finish	
Patas Legs Aluminio pintado en polvo Powder coated aluminum		Granito Granite		Gris Metalizado 56 Gunmetal Grey 56

MESA TAPA TECA TEAK TOP TABLE

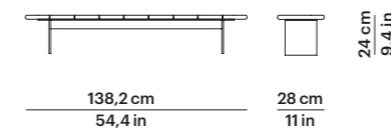

Ref. 77054

Peso Weight 16,5 Kg 36 lb
m³ 0,16 m³

MESA TAPA TECA TEAK TOP TABLE

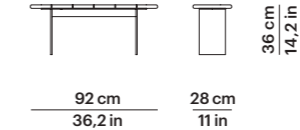

Ref. 77055

Peso Weight 14 Kg 30 lb
m³ 0,15 m³

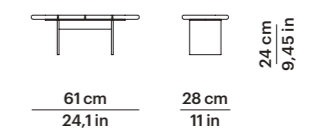

MESA TAPA TECA TEAK TOP TABLE



Ref. 77056

Peso Weight 9 Kg 19 lb
m³ 0,11 m³

Materialos y acabados Materials and finishes

Estructura Frame Teca natural Natural teak	Acabado estructura Frame finish		Acabado patas Legs finish	
Patas Legs Aluminio pintado en polvo Powder coated aluminum		Teca Natural Natural Teak		Gris Metalizado 56 Gunmetal Grey 56

PAL

MESA TAPA TECA TEAK TOP TABLE

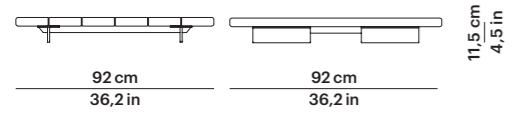

Ref. 77050

Peso Weight 31,5 Kg 69 lb
m³ 0,18 m³

MESA TAPA TECA TEAK TOP TABLE

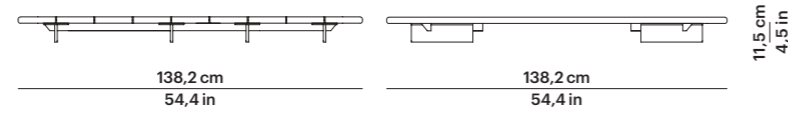

Ref. 77053

Peso Weight 51 Kg 112 lb
m³ 0,44 m³

MESA TAPA TECA TEAK TOP TABLE

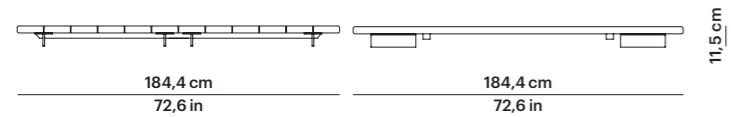

Ref. 77057

Peso Weight 115 Kg 253 lb
m³ 0,74 m³

MESA TAPA TECA TEAK TOP TABLE

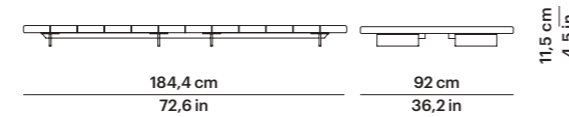

Ref. 77051

Peso Weight 64 Kg 141 lb
m³ 0,38 m³

MESA TAPA TECA TEAK TOP TABLE

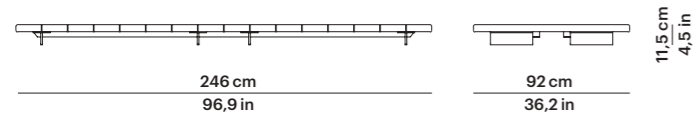

Ref. 77052

Peso Weight 82 Kg 180 lb
m³ 0,5 m³

Materiales y acabados Materials and finishes

Estructura Frame
Teca natural
Natural teak
Patas Legs
Aluminio pintado en polvo
Powder coated aluminum

Acabado estructura Frame finish



Teca Natural
Natural Teak

Acabado patas Legs finish



Gris Metalizado 56
Gunmetal Grey 56

PARALEL

SILLA SIDE CHAIR

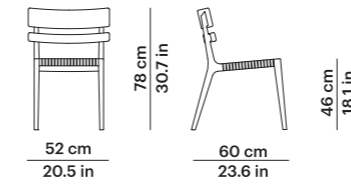

Ref. 77601

Peso Weight 8 Kg 17.6 lb (1 pc)
18 Kg 39.7 lb (2 pcs)
m³ 0,29 m³ (1 pc) - 0,39 m³ (2 pcs)

SILLÓN COMEDOR ARMCHAIR

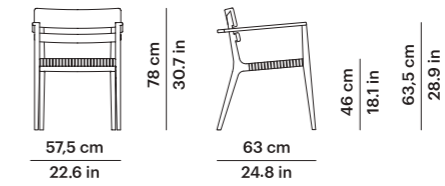

Ref. 77606

Peso Weight 9,7 Kg 21.4 lb (1 pc)
21 Kg 46.3 lb (2 pcs)
m³ 0,35 m³ (1 pc) - 0,58 m³ (2 pcs)

TABURETE BAR STOOL

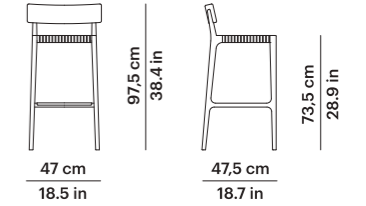

Ref. 77652

Peso Weight 8 Kg 17.6 lb
m³ 0,26 m³

SILLÓN CLUB CLUB LOUNGE CHAIR

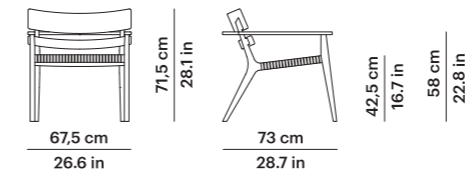

Ref. 77605

Peso Weight 11 Kg 24.3 lb (1 pc)
24 Kg 52.9 lb (2 pcs)
m³ 0,36 m³ (1 pc) - 0,73 m³ (2 pcs)

Materiales y acabados Materials and finishes

Estructura Frame



Teca Natural
Natural Teak

Trenzado Weave

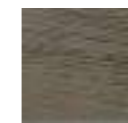

Teca Weathered
Weathered Teak

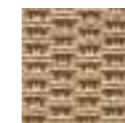

Cuerda Sintética Ø 4 mm
Synthetic Cord Ø 4 mm

PARALEL

SILLÓN LOUNGE CHAIR

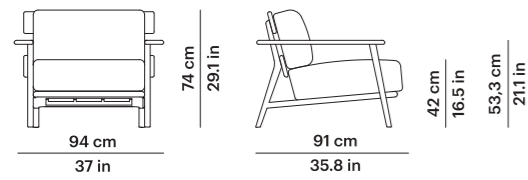

Ref. 77645

Peso Weight 32,8 Kg 72,3 lb
 m³ 0,78 m³
 Cuadrantes Scatter cushions 1 (40x40 cm) (15.8x15.8 in)

SOFÁ 2 SOFA 2

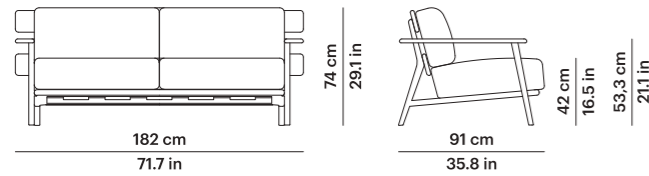

Ref. 77647

Peso Weight 49 Kg 108 lb
 m³ 1,45 m³
 Cuadrantes Scatter cushions 2 (40x40 cm) (15.8x15.8 in)

SOFÁ 3 SOFA 3

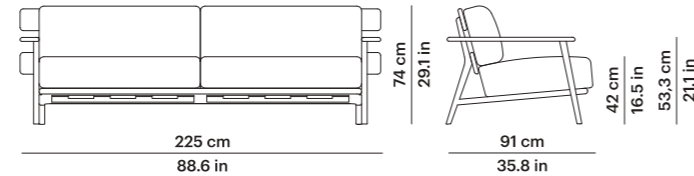

Ref. 77649

Peso Weight 74,4 Kg 164 lb
 m³ 1,82 m³
 Cuadrantes Scatter cushions 3 (40x40 cm) (15.8x15.8 in)

Materiales y acabados Materials and finishes

Estructura Frame



Teca Natural
Natural Teak

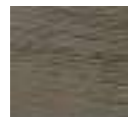

Teca Weathered
Weathered Teak

PARALEL

TUMBONA CHAISE

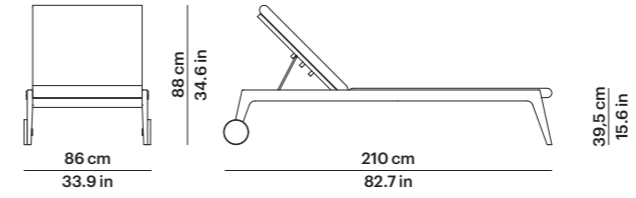

Ref. 77695

Peso Weight 36 Kg 79,4 lb
 m³ 0,64 m³



BRAZO TUMBONA ARM FOR CHAISE

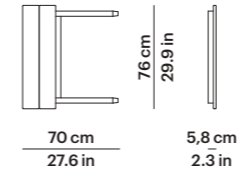

Ref. 77694

Peso Weight 5,4 Kg 11.9 lb
 m³ 0,05 m³

TUMBONA CON BRAZO CHAISE WITH ARM

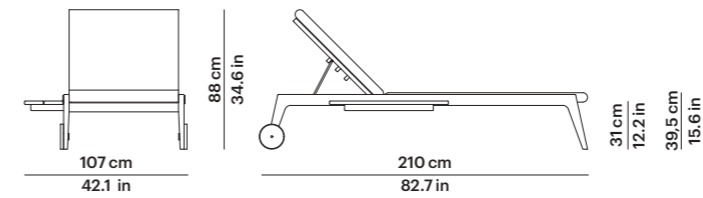

Materiales y acabados Materials and finishes

Estructura Frame



Teca Natural
Natural Teak



Teca Weathered
Weathered Teak

PARALEL

MESA CENTRO RECTANGULAR RECTANGULAR COFFEE TABLE

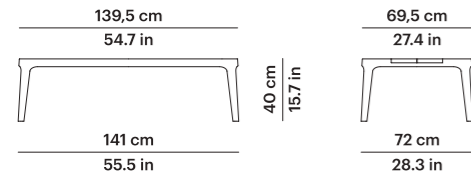

Ref. 77654

Peso Weight 25 Kg 55.1 lb
m³ 0,25 m³

Ref. 77658

Peso Weight 7,1 Kg 0.11 lb
m³ 0,09 m³

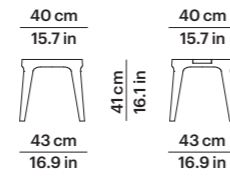

MESA RINCÓN REDONDA ROUND SIDE TABLE

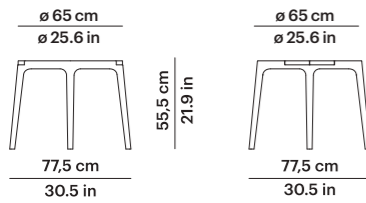

Ref. 77615

Peso Weight 13,5 Kg 29.8 lb
m³ 0,10 m³

MESA RINCÓN CUADRADA SQUARE SIDE TABLE

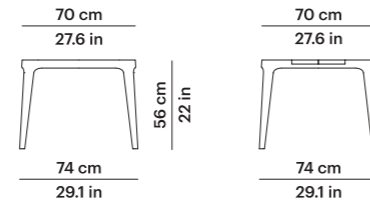

Ref. 77656

Peso Weight 17 Kg 37.5 lb
m³ 0,14 m³

Materiales y acabados Materials and finishes

Estructura Frame



Teca Natural
Natural Teak

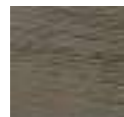

Teca Weathered
Weathered Teak

PARALEL

MESA COMEDOR CUADRADA SQUARE DINING TABLE

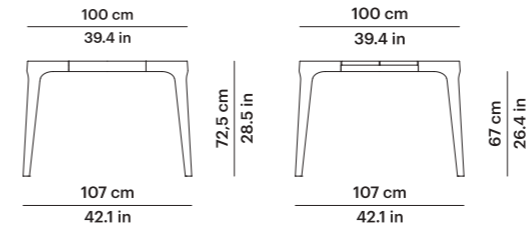

Ref. 77610

Peso Weight 37 Kg 81.6 lb
m³ 0,33 m³

MESA COMEDOR REDONDA ROUND DINING TABLE

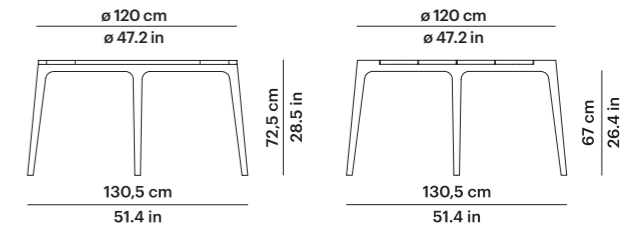

Ref. 77611

Peso Weight 37 Kg 81.6 lb
m³ 0,55 m³

Materiales y acabados Materials and finishes

Estructura Frame



Teca Natural
Natural Teak



Teca Weathered
Weathered Teak

PARALEL

MESA COMEDOR RECTANGULAR RECTANGULAR DINING TABLE

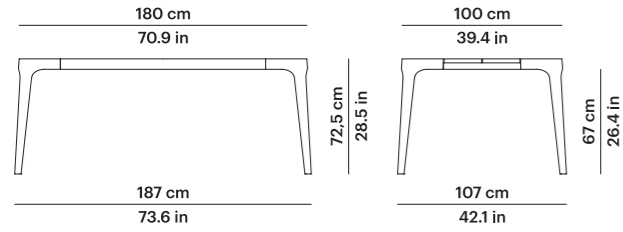

Ref. 77609

Peso Weight 58 Kg 127.9 lb
m³ 0,59 m³

Ref. 77608

Peso Weight 66 Kg 145.5 lb
m³ 0,73 m³

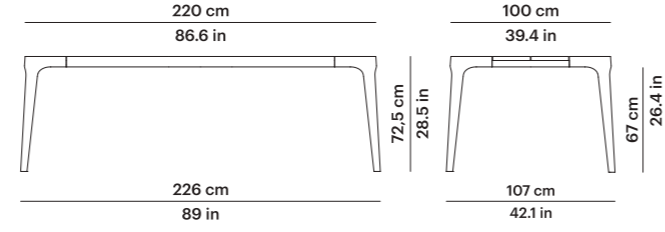

MESA COMEDOR EXTENSIBLE EXTENDABLE DINING TABLE

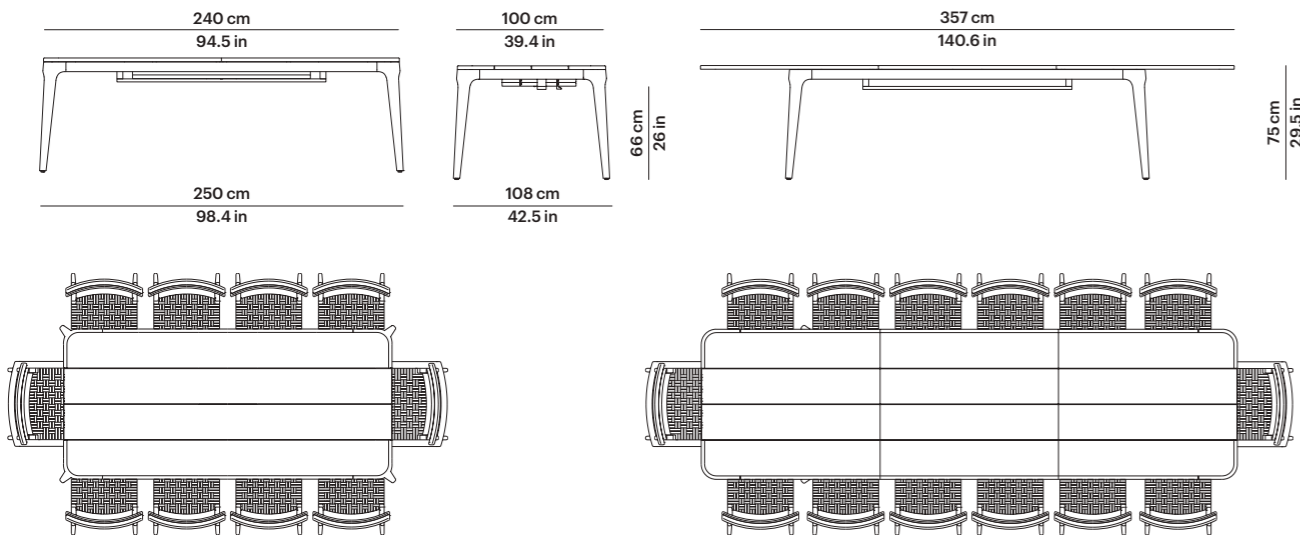

Ref. 77607

Peso Weight 120,3 Kg 265.2 lb
m³ 0,50 m³

Materiales y acabados Materials and finishes

Estructura Frame



Teca Natural
Natural Teak



Teca Weathered
Weathered Teak

ROMANTIC

TUMBONA DAYBED

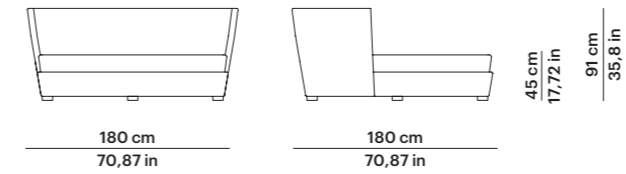

Ref. 71697

Peso Weight 63 Kg 138 lb
m³ 2,96 m³
Cuadrantes Scatter cushions 4 (60x60 cm) (23.6x23.6 in)
3 (50x50 cm) (19.7x19.7 in)
2 (40x40 cm) (15.8x15.8 in)

TUMBONA CON CAPOTA DAYBED WITH CANOPY

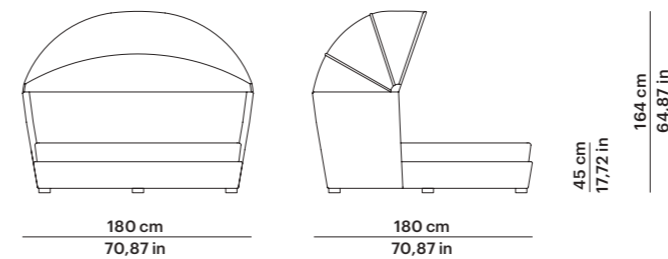

Ref. 71698

Peso Weight 70 Kg 154 lb
m³ 2,96 m³
Cuadrantes Scatter cushions 4 (60x60 cm) (23.6x23.6 in)
3 (50x50 cm) (19.7x19.7 in)
2 (40x40 cm) (15.8x15.8 in)

Materiales y acabados Materials and finishes

Estructura Frame
Aluminio lacado
Lacquered aluminum
Trenzado Weaving
Flat oval 6 mm
Patas Legs
Aluminio anodizado
Anodized aluminum

Acabados Finishes



Marfil 36
Ivory 36



Tostado 03
Toasted 03

ROUND

MESA AUXILIAR REDONDA ROUND SIDE TABLE

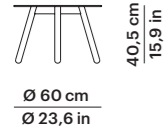

Ref. 76557

Peso con tapa porcelánico Weight with porcelainic top	10,41 Kg 22 lb
Peso con tapa compact Weight with HPL top	7,3 Kg 16 lb
m ³	0,22 m ³

MESA CENTRO REDONDA ROUND COFFEE TABLE

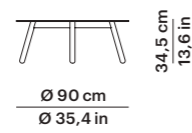

Ref. 76555

Peso con tapa porcelánico Weight with porcelainic top	20,7 Kg 45 lb
Peso con tapa compact Weight with HPL top	13,6 Kg 29 lb
m ³	0,35 m ³

MESA CENTRO REDONDA ROUND COFFEE TABLE

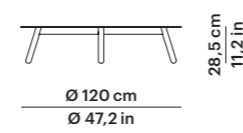

Ref. 76553

Peso con tapa porcelánico Weight with porcelainic top	40 Kg 88 lb
Peso con tapa compact Weight with HPL top	27,5 Kg 60 lb
m ³	0,6 m ³

SAGRA

SILLÓN COMEDOR ARMCHAIR

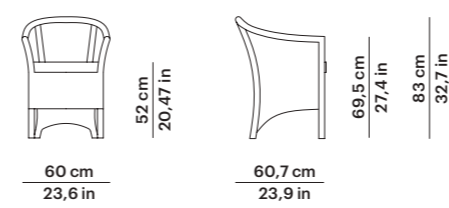

Ref. 70106

Peso Weight	11,5 Kg 25 lb
m ³	0,39 m ³

Materiales y acabados Materials and finishes

Tapa Top
Porcelánico Porcelainic
Compacto HPL
Patas Legs
Teca Teak

Tapa Top
Compacto HPL

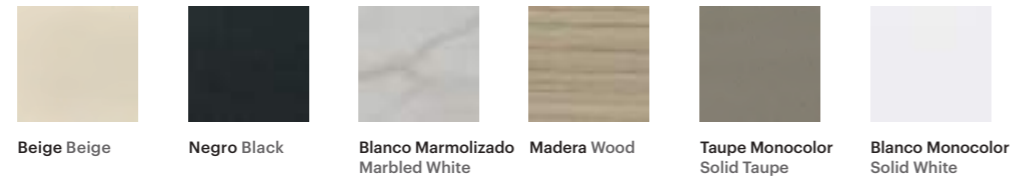

Acabado patas Legs finish



Teca Natural
Natural Teak

Tapa Top
Porcelánico Porcelain

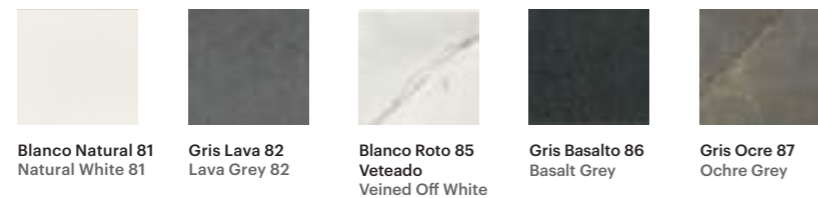

Materiales y acabados Materials and finishes

Estructura Frame
Aluminio lacado Lacquered aluminum
Trenzado Weaving
Round Ø 3 mm

Acabados Finishes



Tostado 03
Toasted 03

SUMMER

SILLA SIDE CHAIR

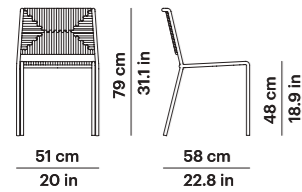

Ref. 77901

Peso Weight 11 Kg 24.2 lb (1 pc)
36,4 Kg 80.2 lb (4 pcs)
m³ 0,34 m³ (1 pc)
0,38 m³ (4 pcs)

TABURETE BAR BAR STOOL

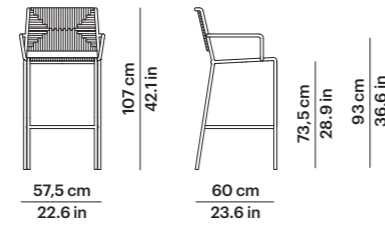

Ref. 77952

Peso Weight 14,4 Kg 31,7 lb
m³ 0,47 m³

SILLÓN COMEDOR ARMCHAIR

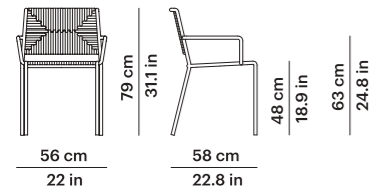

Ref. 77906

Peso Weight 11,4 Kg 25.1 lb (1 pc)
38 Kg 83.8 lb (4 pcs)
m³ 0,32 m³ (1 pc)
0,36 m³ (4 pcs)

SILLÓN CLUB CLUB LOUNGE CHAIR

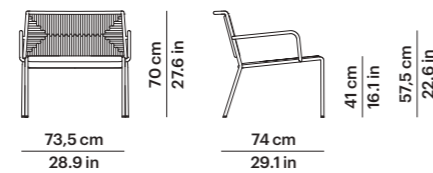

Ref. 77907

Peso Weight 18,1 Kg 39.9 lb (1 pc)
28,7 Kg 63.3 lb (2 pcs)
m³ 0,48 m³ (1 pc)
0,53 m³ (2 pcs)

Materiales y acabados Materials and finishes

Estructura Frame
Aluminio pintado en polvo
Powder coated aluminum



Blanco Mineral 34
Mineral White 34

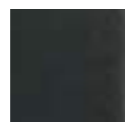

Gris Metalizado 56
Gunmetal Grey 56

Trenzado Weave
Cuerda Ø4mm
Rope Ø4mm



Beige Beige



Gris Perlado
Pearl Grey

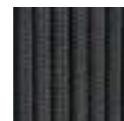

Grafito
Graphite

SUMMER

MESA COMEDOR CUADRADA SQUARE DINING TABLE

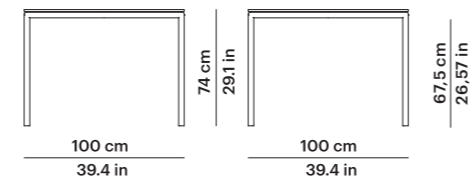

Ref. 77910

Peso Weight 52 Kg con tapa porcelánico
114.6 lb with porcelain top
41 Kg con tapa compacto
90.4 lb with HPL top
m³ 1,03 m³

MESA COMEDOR RECTANGULAR RECTANGULAR DINING TABLE

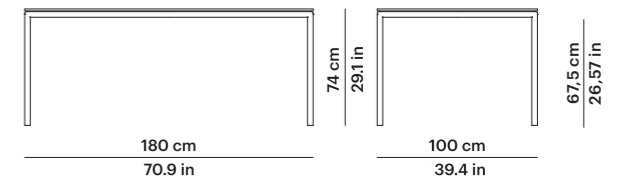

Ref. 77908

Peso Weight 111,7 Kg con tapa porcelánico
246.4 lb with porcelain top
92 Kg con tapa compacto
202.8 lb with HPL top
m³ 1,78 m³

MESA COMEDOR RECTANGULAR RECTANGULAR DINING TABLE

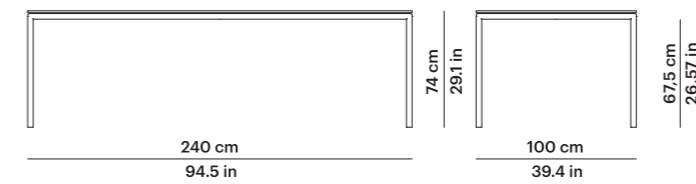

Ref. 77909

Peso Weight 149 Kg con tapa porcelánico
328.5 lb with porcelain top
122,6 Kg con tapa compacto
270.3 lb with HPL top
m³ 2,34 m³

Materiales y acabados Materials and finishes

Estructura Frame
Aluminio pintado en polvo
Powder coated aluminum

Tapa Top
Compacto HPL



Beige Beige



Negro Black

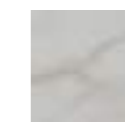

Blanco Marmolizado
Marbled White



Madera Wood



Taupe Monocolor
Solid Taupe

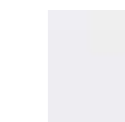

Blanco Monocolor
Solid White

Tapa Top
Porcelánico Porcelain



Blanco Mineral 34
Mineral White 34



Gris Metalizado 56
Gunmetal Grey 56



Blanco Natural 81
Natural White 81



Gris Lava 82
Lava Grey 82



Blanco Roto
Veteado 85
Veined Off White 85



Gris Basalto 86
Basalt Grey 86

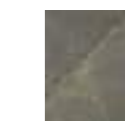

Gris Ocre 87
Ochre Grey 87

SUNSET

TUMBONA DOBLE SIN CORTINAS DOUBLE CHAISE WITH NO CURTAINS

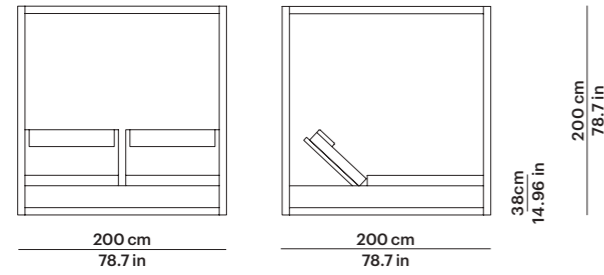

Ref. 74495

Peso Weight 106,5 Kg 234,8 lb
m³ 2,57 m³



TUMBONA DOBLE CON CORTINAS DOUBLE CHAISE WITH CURTAINS

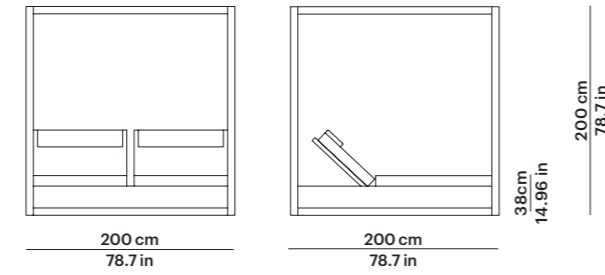

Ref. 74496

Peso Weight 113,5 Kg 250,2 lb
m³ 2,57 m³



WEAVE

SILLA SIDE CHAIR

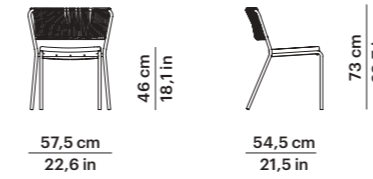

Ref. 77101

Peso Weight 7,7 Kg (1pc) 17 lb (1pc)
24,5 Kg (4pc) 54 lb (4pc)
m³ 0,34 m³ (1pc) - 0,36 m³ (4pc)



SILLÓN COMEDOR ARMCHAIR

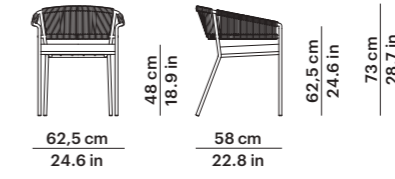

Ref. 77105

Peso Weight 10,1 Kg 22,3 lb (1pc)
24,5 Kg (4pc) 54 lb (4pc)
m³ 0,35 m³ (1pc) - 0,37 m³ (4pc)

SILLÓN COMEDOR ARMCHAIR

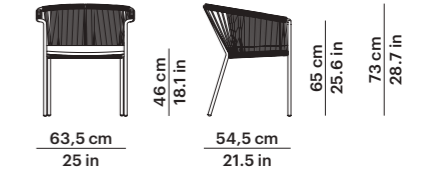

Ref. 77107

Peso Weight 12 Kg 26 lb
m³ 0,33 m³

SILLÓN CLUB CLUB LOUNGE CHAIR

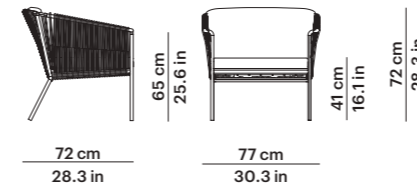

Ref. 77108

Peso Weight 16,5 Kg 36 lb
m³ 0,47 m³

SOFÁ 2 CLUB CLUB SOFA 2

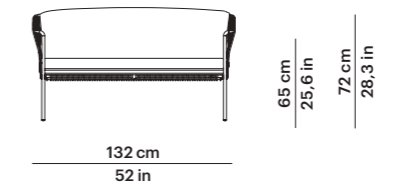

Ref. 77167

Peso Weight 23 Kg 50 lb
m³ 0,78 m³

TABURETE BAR BAR STOOL

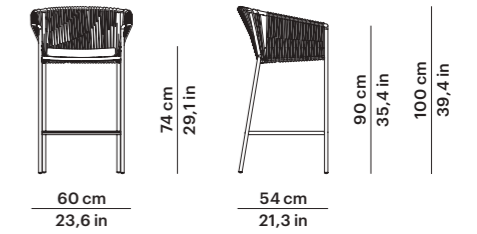

Ref. 77152

Peso Weight 13 Kg 28,7 lb
m³ 0,78 m³

Materiales y acabados Materials and finishes

Estructura Frame
Aluminio lacado
Lacquered aluminum
Trenzado Weaving
Round ø4 mm
Patas Legs
Aluminio anodizado
Anodized aluminum

Acabados Finishes



Marfil 36
Ivory 36

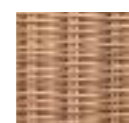

Tostado 03
Toasted 03

Materiales y acabados Materials and finishes

Estructura Frame
Aluminio pintado en polvo
Powder coated aluminum

Trenzado Weaving
Cuerda Ø 8 mm
Rope Ø 8 mm

Acabados Finishes

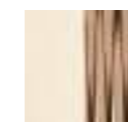

Blanco Mineral -
Turrón 61
Mineral White -
Nougat 61

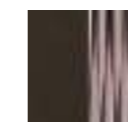

Gris - Taupe 60
Grey - Taupe 60



Negro 59
Black 59

Acabados brazo tumbona Sunbed arm finishes



Blanco Mineral 34
Mineral White 34



Taupe 60
Taupe 60



Negro 59
Black 59

WEAVE

SILLÓN LOUNGE CHAIR

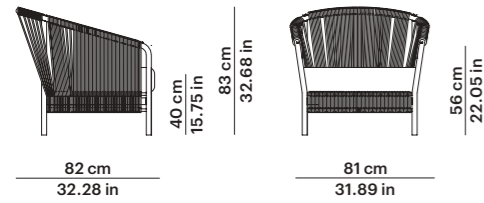

Ref. 78145

Peso Weight	23 Kg 50,6 lb
m ³	0,62 m ³
Cuadrantes	1 (40x40 cm) (15.8x15.8 in)
Scatter cushions	1 (60x60 cm) (23.6x23.6 in)

SOFÁ 2 SOFA 2

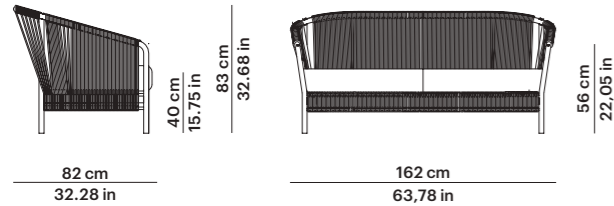

Ref. 78147

Peso Weight	44,8 Kg 98,7 lb
m ³	1,21 m ³
Cuadrantes	4 (40x40 cm) (15.8x15.8 in)
Scatter cushions	2 (60x60 cm) (23.6x23.6 in)

SOFÁ 3 SOFA 3

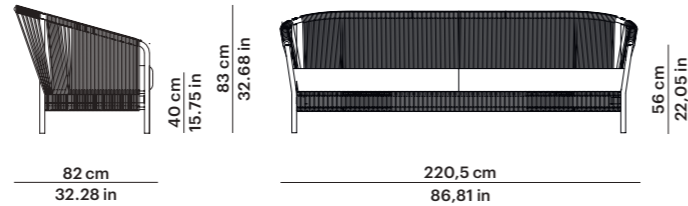

Ref. 78149

Peso Weight	48,5 Kg 106,9 lb
m ³	1,62 m ³
Cuadrantes	5 (40x40 cm) (15.8x15.8 in)
Scatter cushions	3 (60x60 cm) (23.6x23.6 in)

Materiales y acabados Materials and finishes

Estructura Frame
Aluminio pintado en polvo
Powder coated aluminum

Trenzado Weaving
Cuerda Ø 8 mm
Rope Ø 8 mm

Acabados Finishes

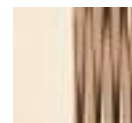

Blanco Mineral -
Turrón 61
Mineral White -
Nougat 61

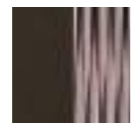

Gris - Taupe 60
Grey - Taupe 60



Negro 59
Black 59

Acabados brazo tumbona Sunbed arm finishes



Blanco Mineral 34
Mineral White 34



Taupe 60
Taupe 60



Negro 59
Black 59

WEAVE

TUMBONA REDONDA ROUND DAYBED

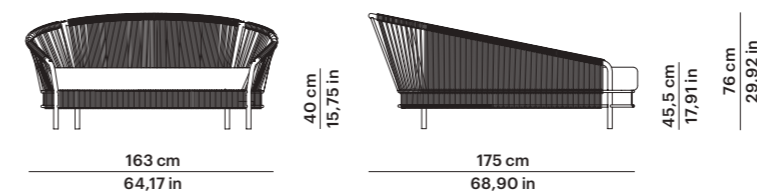

Ref. 78195

Peso Weight	72,7 Kg 160,3 lb
m ³	2,51 m ³
Cuadrantes Scatter cushions	2 (40x40 cm) (15.8x15.8 in)
	3 (50x50 cm) (19.7x19.7 in)
	4 (60x60 cm) (23.6x23.6 in)

PUF OTTOMAN

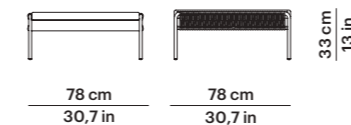

Ref. 77155

Peso Weight	15,2 Kg 33 lb
m ³	0,25 m ³

TUMBONA CHAISE

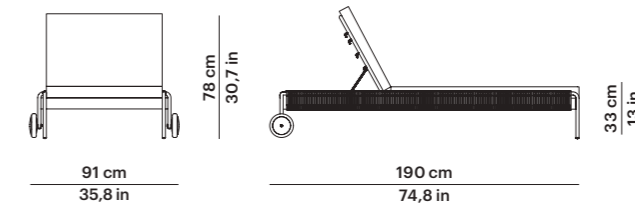

Ref. 77195

Peso Weight	42,5 Kg 93 lb
m ³	0,66 m ³

SILLÓN RECLINABLE RECLINING ARMCHAIR

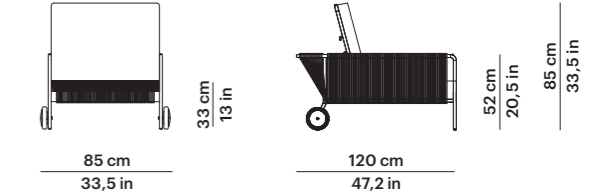

Ref. 77198

Peso Weight	30,5 Kg 67 lb
m ³	0,653 m ³
Cuadrantes Scatter cushions	1 (40x40 cm) (15.8x15.8 in)

BRAZO TUMBONA CHAISE ARM

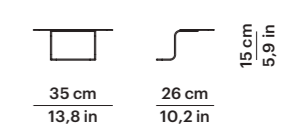

Ref. 77194

Peso Weight	2,5 Kg 5 lb
m ³	0,01 m ³

Materiales y acabados Materials and finishes

Estructura Frame
Aluminio pintado en polvo
Powder coated aluminum

Trenzado Weaving
Cuerda Ø 8 mm
Rope Ø 8 mm

Acabados Finishes

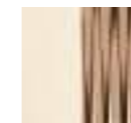

Blanco Mineral -
Turrón 61
Mineral White -
Nougat 61

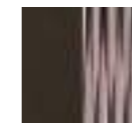

Gris - Taupe 60
Grey - Taupe 60



Negro 59
Black 59

Acabados brazo tumbona Sunbed arm finishes



Blanco Mineral 34
Mineral White 34



Taupe 60
Taupe 60



Negro 59
Black 59

WEAVE

PIE DE MESA TABLE BASE

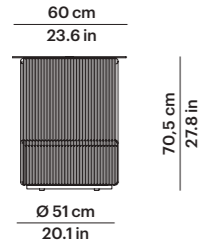

Ref. 78114

Peso Weight	37,4 Kg 82.5 lb
m ³	0,33 m ³
Medida tapa	Ø 120 - Ø 130 cm
Top size	Ø 47.2 - Ø 51.1 In

PIE MESA ALTO 4 PATAS HIGHT TABLE BASE 4 LEGS

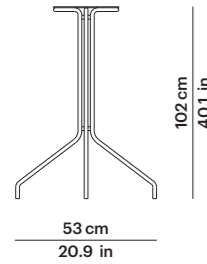

Ref. 77112

Peso Weight	12 Kg 26 lb
m ³	0,34 m ³
Medida tapa	Ø 70 - Ø 80 - Ø 90 cm
Top size	70x70 - 80x80 - 90x90 cm
	Ø 27.6 - Ø 31.5 - Ø 35.4 In
	27.6x27.6 - 31.5x31.5 - 35.4x35.4 In

PIE MESA 4 PATAS TABLE BASE 4 LEGS

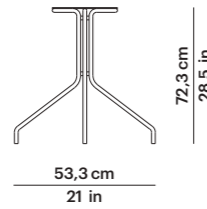

Ref. 77115

Peso Weight	10,5 Kg 23 lb
m ³	0,28 m ³
Medida tapa	Ø 70 - Ø 80 - Ø 90 cm
Top size	70x70 - 80x80 - 90x90 cm
	Ø 27.6 - Ø 31.5 - Ø 35.4 In
	27.6x27.6 - 31.5x31.5 - 35.4x35.4 In

PIE MESA DOBLE 4 PATAS DOUBLE TABLE BASE TOP 4 LEGS

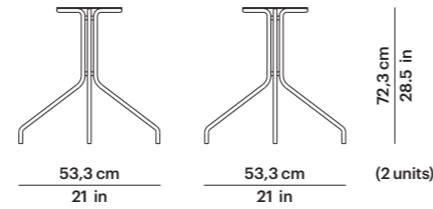

Ref. 77109

Peso Weight	21 Kg 246 lb
m ³	0,56 m ³
Medida tapa	160x90 cm
Top size	63x35.4 In

Materiales y acabados Materials and finishes

Estructura Frame
Aluminio pintado en polvo
Powder coated aluminum

Acabados Finishes

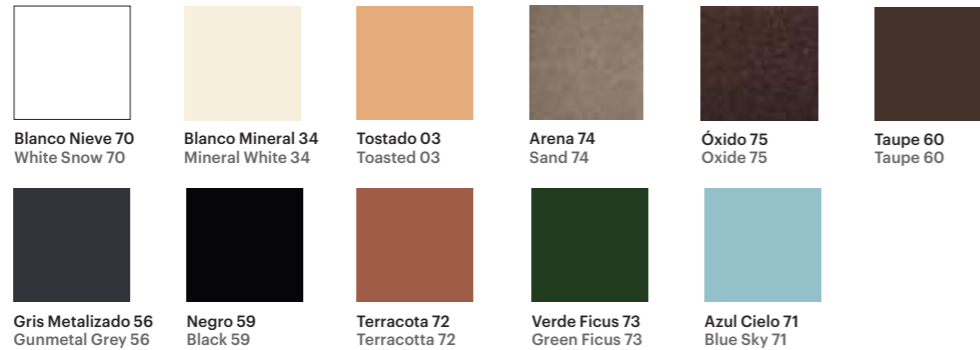

WEAVE

COLUMPIO SWING

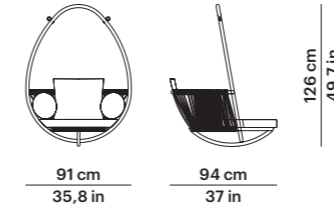

Ref. 77192

Peso Weight	16,5 Kg 36 lb
m ³	1,21 m ³
Cuadrantes	2 (Ø 32 cm) (Ø 12.6 in)
Scatter cushions	1 (60x45 cm) (23.6x17.7 in)

COLUMPIO CON BASE SWING WITH BASE

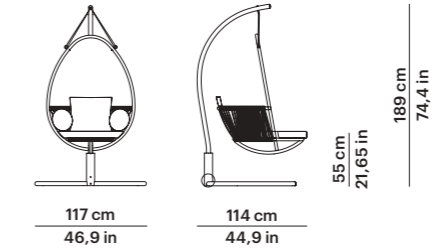

Ref. 77193

Peso Weight	32 Kg 70 lb
m ³	1,50 m ³
Cuadrantes	2 (Ø 32 cm) (Ø 12.6 in)
Scatter cushions	1 (60x45 cm) (23.6x17.7 in)

PUF OTTOMAN

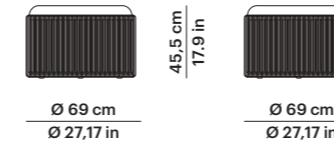

Ref. 78152

Peso Weight	14,8 Kg 32.6 lb
m ³	0,29 m ³

PUF OTTOMAN

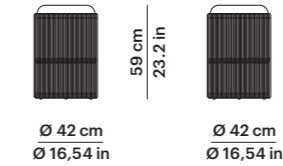

Ref. 78155

Peso Weight	9,3 Kg 20.5 lb
m ³	0,15 m ³

PUF OTTOMAN

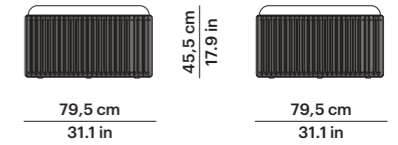

Ref. 78158

Peso Weight	20,3 Kg 44.8 lb
m ³	0,38 m ³

Materiales y acabados Materials and finishes

Estructura Frame
Aluminio pintado en polvo
Powder coated aluminum

Acabados Finishes

Trenzado Weaving
Cuerda Ø 8 mm
Rope Ø 8 mm

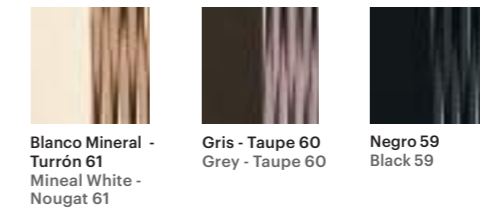

WEAVE

MESA CENTRO REDONDA ROUND COFFEE TABLE

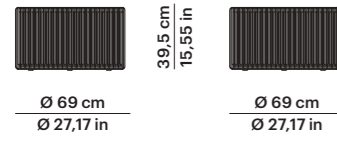

Ref. 78153

Peso Weight 21 Kg con tapa porcelánico
46.3 lb with porcelain top
16 Kg con tapa compacto
35.2 lb with HPL top

m³ 0,25 m³

MESA RINCÓN REDONDA ROUND SIDE TABLE

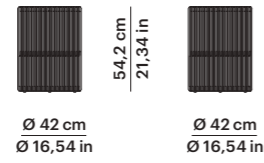

Ref. 78156

Peso Weight 10,4 Kg con tapa porcelánico
23 lb with porcelain top
9 Kg con tapa compacto
19.8 lb with HPL top

m³ 0,13 m³

MESA DE CENTRO CUADRADA SQUARE COFFEE TABLE

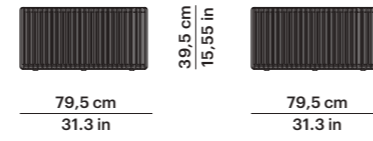

Ref. 78159

Peso Weight 30,6 Kg con tapa porcelánico
67.5 lb with porcelain top
22,9 Kg con tapa compacto
50.5 lb with HPL top

m³ 0,33 m³

WEAVE

JARDINERA PLANTER

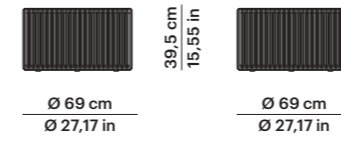

Ref. 78151

Peso Weight 13,4 Kg con cubeta
29.5 lb with tray
11,8 Kg sin cubeta
26 lb without tray

m³ 0,25 m³

JARDINERA PLANTER

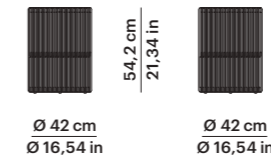

Ref. 78154

Peso Weight 8,9 Kg con cubeta
19.6 lb with tray
8,3 Kg sin cubeta
18.3 lb without tray

m³ 0,13 m³

JARDINERA PLANTER

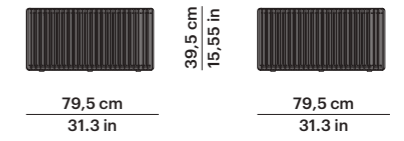

Ref. 78157

Peso Weight 18,3 Kg con cubeta
40.3 lb with tray
15,7 Kg sin cubeta
34.5 lb without tray

m³ 0,33 m³

CUBETA PARA JARDINERA TRAY FOR PLANTER



CUBETA PARA JARDINERA TRAY FOR PLANTER



CUBETA PARA JARDINERA TRAY FOR PLANTER



Materiales y acabados Materials and finishes

Estructura Frame
Aluminio pintado en polvo
Powder coated aluminum

Trenzado Weaving
Cuerda Ø 8 mm
Rope Ø 8 mm

Acabados Finishes

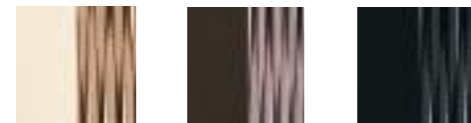

Blanco Mineral -
Turrón 61
Mineal White -
Nougat 61

Gris - Taupe 60
Grey - Taupe 60

Negro 59
Black 59

Tapa Top Compacto HPL



Beige Beige

Negro Black

Blanco Marmolizado
Marbled White

Madera Wood

Taupe Monocolor
Solid Taupe

Blanco Monocolor
Solid White

Tapa Top Porcelánico Porcelain



Blanco Natural 81
Natural White 81

Gris Lava 82
Lava Grey 82

Blanco Roto
Veteado 85
Veined Off White 85

Gris Basalto 86
Basalt Grey 86

Gris Ocre 87
Ochre Grey 87

Materiales y acabados Materials and finishes

Estructura Frame
Aluminio pintado en polvo
Powder coated aluminum

Trenzado Weaving
Cuerda Ø 8 mm
Rope Ø 8 mm

Acabados Finishes

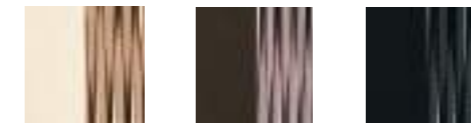

Blanco Mineral -
Turrón 61
Mineal White -
Nougat 61

Gris - Taupe 60
Grey - Taupe 60

Negro 59
Black 59

TOPS TAPAS COMPACTOS HPL TOPS

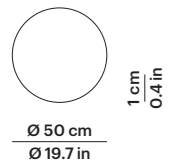

Ref. 74304

Peso Weight 3,7 Kg 8.3 lb
m³ 0,03 m³

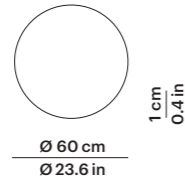

Ref. 74305

Peso Weight 5 Kg 10.9 lb
m³ 0,04 m³

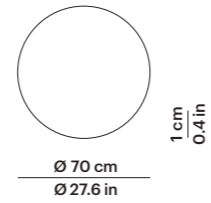

Ref. 74314

Peso Weight 6,6 Kg 14.5 lb
m³ 0,04 m³

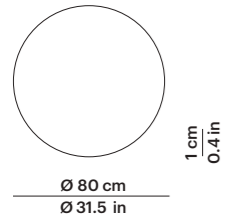

Ref. 74309

Peso Weight 8,5 Kg 18.8 lb
m³ 0,05 m³

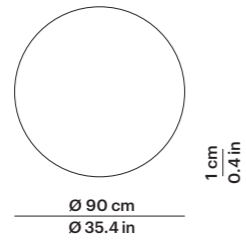

Ref. 74307

Peso Weight 10,6 Kg 23.3 lb
m³ 0,06 m³

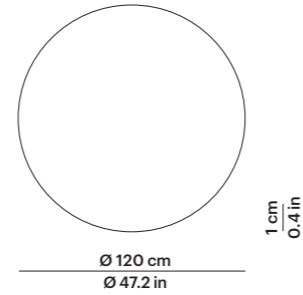

Ref. 74317

Peso Weight 17,8 Kg 39.3 lb
m³ 0,12 m³

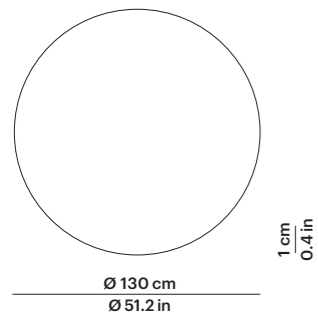

Ref. 74316

Peso Weight 20,6 Kg 45.4 lb
m³ 0,14 m³

Materiales y acabados Materials and finishes

Tapa Top
Compacto HPL



Beige Beige Negro Black Blanco Marmolizado Marbled White Madera Wood Taupe Monocolor Solid Taupe Blanco Monocolor Solid White

TOPS TAPAS COMPACTOS HPL TOPS

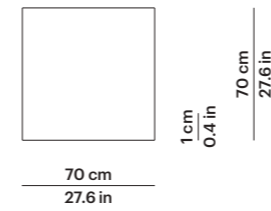

Ref. 74315

Peso Weight 8,1 Kg 17.8 lb
m³ 0,04 m³

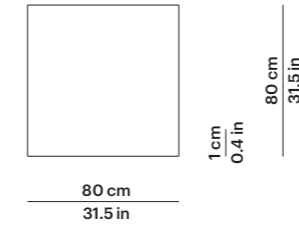

Ref. 74310

Peso Weight 10,5 Kg 23.1 lb
m³ 0,05 m³

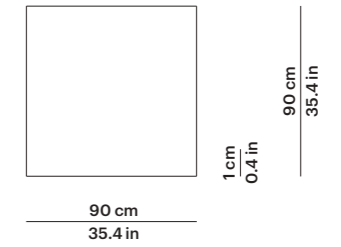

Ref. 74311

Peso Weight 13 Kg 28.7 lb
m³ 0,06 m³

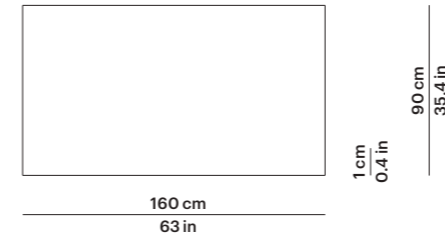

Ref. 74308

Peso Weight 22,2 Kg 48.9 lb
m³ 0,11 m³

Materiales y acabados Materials and finishes

Tapa Top
Compacto HPL



Beige Beige Negro Black Blanco Marmolizado Marbled White Madera Wood Taupe Monocolor Solid Taupe Blanco Monocolor Solid White

TOPS TAPAS PORCELÁNICOS PORCELAIN TOPS



Ref. 74304

Peso Weight 6,7 Kg 14.8 lb
m³ 0,03 m³



Ref. 74305

Peso Weight 9,2 Kg 23.6 lb
m³ 0,04 m³

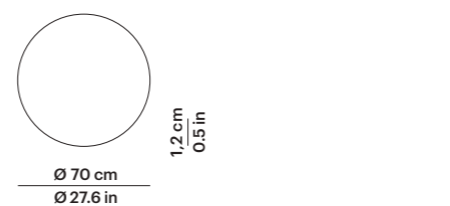

Ref. 74314

Peso Weight 12,4 Kg 27.2 lb
m³ 0,04 m³

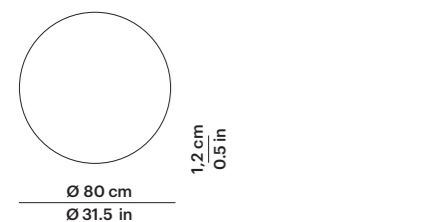

Ref. 74309

Peso Weight 16,1 Kg 35.4 lb
m³ 0,05 m³

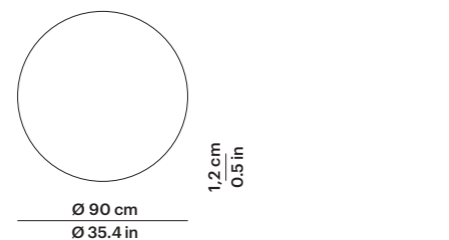

Ref. 74307

Peso Weight 20,1 Kg 44.2 lb
m³ 0,06 m³

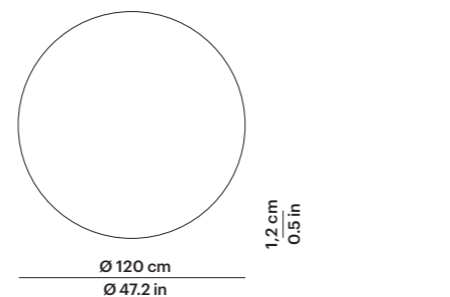

Ref. 74317

Peso Weight 34,8 Kg 76.7 lb
m³ 0,12 m³

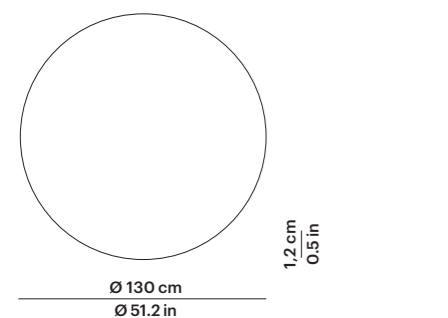

Ref. 74316

Peso Weight 40,5 Kg 89.3 lb
m³ 0,14 m³

Materiales y acabados Materials and finishes

Tapa Top
Porcelánico Porcelain



Blanco Natural 81 Natural White 81
Gris Lava 82 Lava Grey 82
Blanco Roto Veteado 85 Veined Off White 85
Gris Basalto 86 Basalt Grey 86
Gris Ocre 87 Ochre Grey 87

TOPS TAPAS PORCELÁNICOS PORCELAIN TOPS

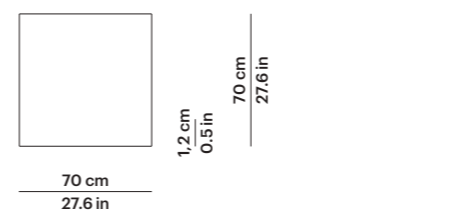

Ref. 74315

Peso Weight 15,4 Kg 34 lb
m³ 0,04 m³

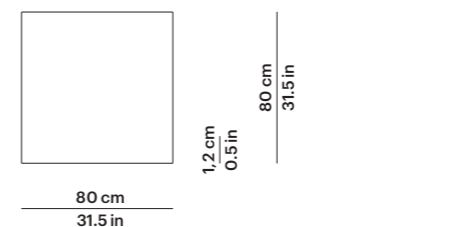

Ref. 74310

Peso Weight 20,1 Kg 44.2 lb
m³ 0,05 m³

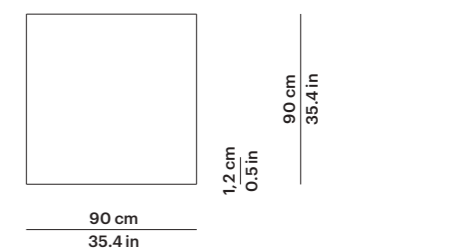

Ref. 74311

Peso Weight 25,2 Kg 55.4 lb
m³ 0,06 m³

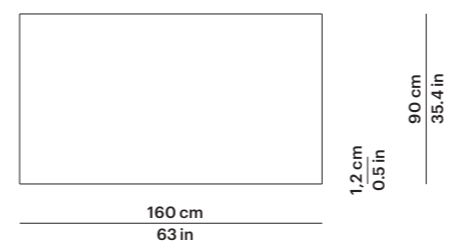

Ref. 74308

Peso Weight 43,8 Kg 96.5 lb
m³ 0,11 m³

Materiales y acabados Materials and finishes

Tapa Top
Porcelánico Porcelain



Blanco Natural 81 Natural White 81
Gris Lava 82 Lava Grey 82
Blanco Roto Veteado 85 Veined Off White 85
Gris Basalto 86 Basalt Grey 86
Gris Ocre 87 Ochre Grey 87

TOPS TAPAS TECA TEAK TOPS



Ø 50 cm
Ø 19.7 in

Ref. 74304

Peso Weight 1,8 Kg 6.3 lb
m³ 0,03 m³

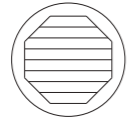

Ø 60 cm
Ø 23.6 in

Ref. 74305

Peso Weight 2,7 Kg 8 lb
m³ 0,04 m³

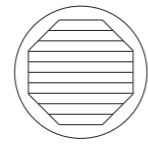

Ø 70 cm
Ø 27.6 in

Ref. 74314

Peso Weight 3,6 Kg 10.6 lb
m³ 0,04 m³

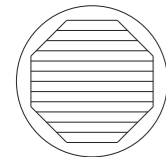

Ø 80 cm
Ø 31.5 in

Ref. 74309

Peso Weight 4,6 Kg 13.4 lb
m³ 0,05 m³

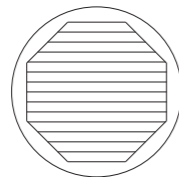

Ø 90 cm
Ø 35.4 in

Ref. 74307

Peso Weight 5,6 Kg 16 lb
m³ 0,06 m³

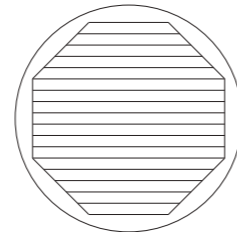

Ø 120 cm
Ø 47.2 in

Ref. 74317

Peso Weight 10,1 Kg 26.6 lb
m³ 0,12 m³

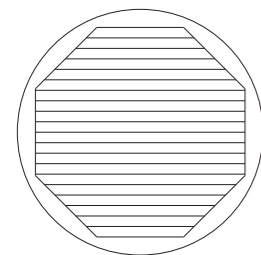

Ø 130 cm
Ø 51.2 in

Ref. 74316

Peso Weight 10,4 Kg 27.6 lb
m³ 0,14 m³

Materiales y acabados Materials and finishes

Estructura Frame



Teca Natural
Natural Teak

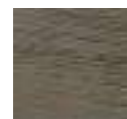

Teca Weathered
Weathered Teak

TOPS TAPAS TECA TEAK TOPS



70 cm
27.6 in

Ref. 74315

Peso Weight 4,6 Kg 12.8 lb
m³ 0,04 m³

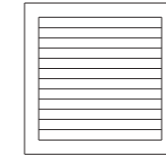

80 cm
31.5 in

Ref. 74310

Peso Weight 5,9 Kg 16.2 lb
m³ 0,05 m³

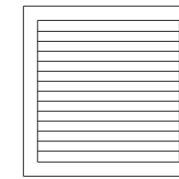

90 cm
35.4 in

Ref. 74311

Peso Weight 7,2 Kg 19.5 lb
m³ 0,06 m³

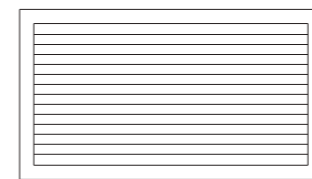

160 cm
63 in

Ref. 74308

Peso Weight 12,8 Kg 32.6 lb
m³ 0,11 m³

Materiales y acabados Materials and finishes

Estructura Frame



Teca Natural
Natural Teak

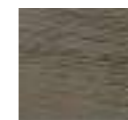

Teca Weathered
Weathered Teak

COVERS

FUNDA ADAPTADA PARA CADA MODELO COVER ADAPTED TO EACH MODEL



MATERIAL DE TEJIDO BASE
Hilo
Tejido
Acabado Finish

Peso Weight
Resist. al frío Cold resist.
Resist. al calor Heat resist.
Resist. a la interperie

pes din en iso 2076
370/540 dtex din en iso 2060
1/1
tratamiento fungicida, repelente
a la suciedad
240g/m² en iso 2286-2
-25°C en 1876-1
+70°C pa 07.04 (intern)
6-8 note, value en iso 105 b04

SÍMBOLOS SIMBOLS

Apilable
Stacking

Patas regulables
Adjustable legs

Abatible
Swing

Ruedas
Wheels

* Los pesos y m³ incluyen el embalaje
* Total weight and m³ including packaging

BEACH

PARASOL UMBRELLA

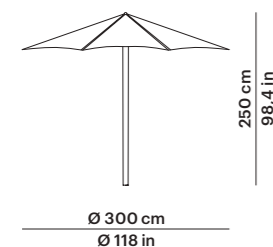

Ref. 84602

Peso Weight 13,4 Kg 29,5 lb
m³ 0,20 m³

Materiales Materials

Estructura Frame
Aluminio lacado
Lacquered aluminum

Telas Fabrics
Grupo 1-21 Group 1-21
Batylne

PARASOL UMBRELLA

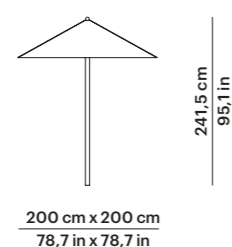

Ref. 84601

Peso Weight 6,4 Kg 14,1 lb
m³ 0,14 m³

Estructura Frame
Aluminio + varillas fibra de vidrio
Aluminum + glass fiber ribs

Telas Fabrics
Grupo 1-21 Group 1-21
Batylne

Materiales y acabados Materials and finishes

Acabado estructura
Frame finish



Aluminio Lacado Blanco
White Lacquered Aluminum

Acabados telas
Fabrics finishes



Grupo 1-21
Group 1-21



Batylne 35



Batylne 37



Batylne 38



Batylne 57



Batylne 39



Batylne 40

BASE DE PARASOL UMBRELLA BASE

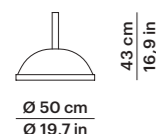

Ref. 84603

Peso Weight 39 Kg 85 lb
m³ 0,07 m³

Materiales y acabados Materials and finishes

Estructura Frame
Aluminio lacado + hormigón
Lacquered aluminum + concrete

BASE DE PARASOL UMBRELLA BASE

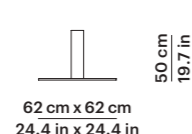

Ref. 84604

Peso Weight 31 Kg 68 lb
m³ 0,11 m³

Estructura Frame
Base metal
Metal base

Acabado estructura Frame finish



Aluminio Lacado Blanco
White Lacquered Aluminum

OMBRA

PARASOL UMBRELLA

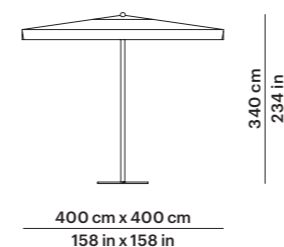

Ref. 84804

Peso Weight 194 Kg 427 lb
m³ 0,40 m³

BASE DE PARASOL UMBRELLA BASE

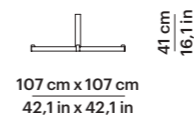

Peso Weight 168,5 Kg 371 lb
m³ 0,16 m³

Materiales y acabados Materials and finishes

Estructura Frame
Aluminio lacado
Lacquered aluminum
Telas Fabrics
Grupo 1-21 Group 1-21
Batylne

Acabado estructura
Frame finish



Aluminio Lacado Blanco
White Lacquered Aluminum

Acabados telas
Fabrics finishes



Grupo 1-21
Group 1-21



Batylne 35



Batylne 37



Batylne 38



Batylne 57



Batylne 39



Batylne 40

Estructura Frame
Aluminio lacado
Lacquered aluminum

Materiales Materials
4 baldosas de cerámica de 35 kg cada una
4 ceramic tiles 77 lb each one

ROMA

PARASOL UMBRELLA

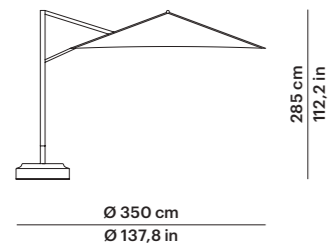

Ref. 84705

Peso Weight 56,3 Kg 124,2 lb
m³ 0,40 m³

PARASOL UMBRELLA

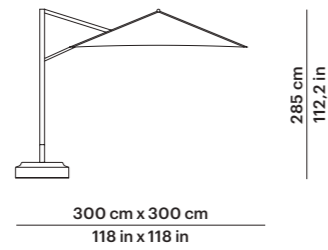

Ref. 84704

Peso Weight 64,5 Kg 142,2 lb
m³ 0,40 m³

Materiales y acabados Materials and finishes

Estructura Frame

Aluminio lacado
Lacquered aluminum

Telas Fabrics

Grupo 1-21 Group 1-21
Batylite

Acabado estructura Frame finish



Aluminio Lacado Blanco
White Lacquered Aluminum

Acabados telas Fabrics finishes



Grupo 1-21
Group 1-21



Batylite 35



Batylite 37



Batylite 38



Batylite 57



Batylite 39



Batylite 40

ROMA

BASE DE PARASOLES UMBRELLA BASE

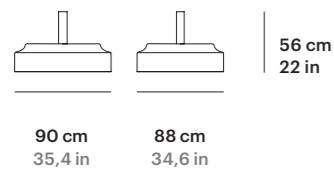

Peso Weight 33 Kg sin arena 72 lb without sand
132 Kg con arena 291 lb with sand
m³ 0,16 m³

Materiales y acabados Materials and finishes

Estructura Frame
Aluminio lacado
Lacquered aluminum

Patas Legs
Pvc con ruedas
Pvc with wheels

CITY

LONG ISLAND

Método de suspensión con lamas Slatted support system

Método de suspensión con lamas de polipropileno reforzadas con fibra de vidrio. Material 100% reciclado.

Estas dos colecciones, City & Long Island, cuentan con el método de lamas GOODSIDE. Se trata de un método de suspensión con lamas que se combinan con espuma. Las lamas se insertan entre dos capas de espuma cortada consiguiendo así mayor resistencia.

Se trata de un material absolutamente higiénico ya que no absorbe humedad y se puede limpiar con detergentes de limpieza normales sin dañar la superficie.

Los listones GOODSIDE resistentes a la intemperie permiten el uso en exteriores durante todo el año.

Los cojines con este sistema llevan siempre incluida la funda impermeable.

Method of suspension with fibreglass-reinforced polypropylene slats. 100% recycled material.

These two collections, City & Long Island, feature the GOODSIDE slat method. It is a suspension solution that uses slats combined with foam. The slats are inserted between two layers of cut foam for increased strength.

This is an absolutely hygienic material as it does not absorb moisture and can be cleaned with normal cleaning detergents without damaging the surface.

Weatherproof GOODSIDE slats can be used outdoors all year round.

With this system, the cushions always include a waterproof cover.

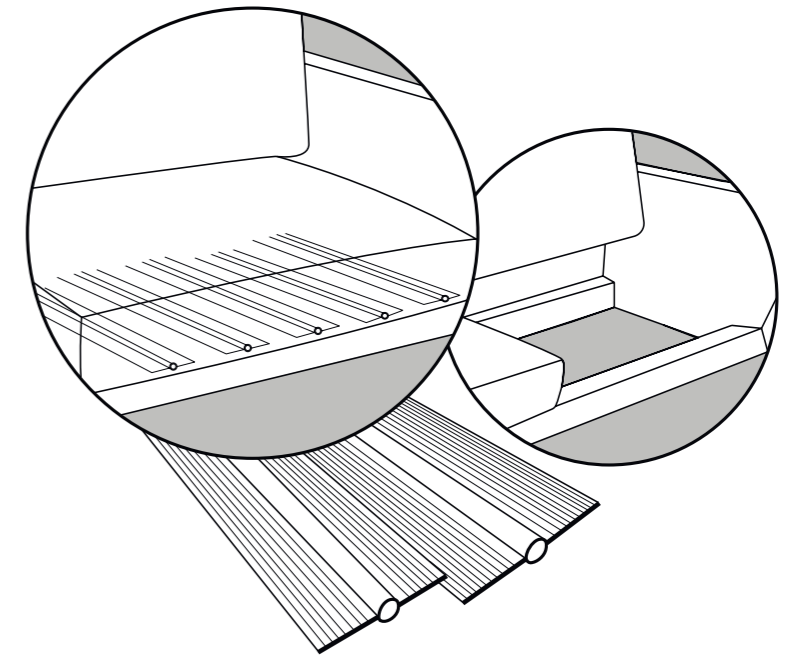

GOODSIDE



COMPOSICIONES SUGERIDAS SUGGESTED COMPOSITIONS

LONG ISLAND

Composición 1 Composition 1



Uds. Units	Ref.	Descripción Description
1	77840	Sofá 2 Modular Brazo Derecho Right Arm Sectional Sofa 2
1	77844	Rinconera Corner
1	77843	Sofá 3 Modular Brazo Izquierdo Left Arm Sectional Sofa 3
1	77853	Mesa Centro Cuadrada Tapa Porcelánico Square Coffee Table Porcelain Top

Composición 2 Composition 2



Uds. Units	Ref.	Descripción Description
1	77840	Sofá 2 Modular Brazo Derecho Right Arm Sectional Sofa 2
2	77844	Rinconera Corner
1	77848	Sofá 3 Modular Sin Brazos Without Arms Sectional Sofa 3
1	77841	Sofá 2 Modular Brazo Izqdo. Left Arm Sectional Sofa 2
1	77853	Mesa Centro Cuadrada Tapa Porcelánico Square Coffee Table Porcelain Top

Composición 3 Composition 3



Uds. Units	Ref.	Descripción Description
1	77842	Sofá 3 Modular Brazo Derecho Right Arm Sectional Sofa 3
1	77897	Chaise Longue Brazo Izquierdo Chaise Longue Left Arm
1	77854	Mesa Centro Rectangular Tapa Porcelánico Rectangular Coffee Table Porcelain Top

LONG ISLAND

Composición 4 Composition 4



Uds. Units	Ref.	Descripción Description
1	77840	Sofá 2 Modular Brazo Derecho Right Arm Sectional Sofa 2
1	77841	Sofá 2 Modular Brazo Izqdo. Left Arm Sectional Sofa 2
2	77853	Mesa Centro Cuadrada Tapa Porcelánico Square Coffee Table Porcelain Top

Composición 5 Composition 5



Uds. Units	Ref.	Descripción Description
1	77843	Sofá 3 Modular Brazo Izquierdo Left Arm Sectional Sofa 3
1	77842	Sofá 3 Modular Brazo Derecho Right Arm Sectional Sofa 3
2	77853	Mesa Centro Cuadrada Tapa Porcelánico Square Coffee Table Porcelain Top

Composición 6 Composition 6



Uds. Units	Ref.	Descripción Description
1	77843	Sofá 3 Modular Brazo Izq. Left Arm Sectional Sofa 3
1	77844	Rinconera Corner
1	77842	Sofá 3 Mod. Brazo Dcho. Right Arm Sectional Sofa 3
1	77853	Mesa Centro Cuadrada Tapa Porcelánico Square Coffee Table Porcelain Top

Composición 7 Composition 7



Uds. Units	Ref.	Descripción Description
1	77897	Chaise Longue Brazo Izquierdo Chaise longue Left Arm
1	77896	Chaise Longue Brazo Derecho Chaise longue Right Arm

Composición 1 Composition 1



Uds. Units	Ref.	Descripción Description
1	79142	Sofá 3 modular brazo derecho Right arm sectional sofa 3
1	79144	Sofá 2 modular brazo derecho Right arm sectional sofa 2
1	79146	Sofá 2 modular brazo izquierdo Left arm sectional sofa 2
1	79153	Mesa centro cuadrada tapa porcelánico Square coffee table porcelain top

Composición 2 Composition 2



Uds. Units	Ref.	Descripción Description
1	79144	Sofá 2 modular brazo derecho Right arm sectional sofa 2
1	79146	Sofá 2 modular brazo izquierdo Left arm sectional sofa 2
1	79154	Mesa centro rectangular tapa porcelánico Rectangular coffee table porcelain top

Composición 3 Composition 3



Uds. Units	Ref.	Descripción Description
1	79142	Sofá 3 modular brazo derecho Right arm sectional sofa 3
1	79143	Sofá 3 modular brazo izquierdo Left arm sectional sofa 3
1	79144	Sofá 2 modular brazo derecho Right arm sectional sofa 2
1	79146	Sofá 2 modular brazo izquierdo Left arm sectional sofa 2
1	79153	Mesa centro cuadrada tapa aluminio Square coffee table aluminum top

Composición 4 Composition 4



Uds. Units	Ref.	Descripción Description
1	79142	Sofá 3 modular brazo derecho Right arm sectional sofa 3
1	79143	Sofá 3 modular brazo izquierdo Left arm sectional sofa 3
2	79153	Mesa centro cuadrada tapa porcelánico Square coffee table porcelain top

Composición 5 Composition 5



Uds. Units	Ref.	Descripción Description
1	79144	Sofá 2 modular brazo derecho Right arm sectional sofa 2
1	79146	Sofá 2 modular brazo izquierdo Left arm sectional sofa 2
4	79145	Sillón Lounge chair
2	79153	Mesa centro cuadrada tapa aluminio Square coffee table aluminum top

Composición 6 Composition 6



Uds. Units	Ref.	Descripción Description
1	79144	Sofá 2 modular brazo derecho Right arm sectional sofa 2
2	79146	Sofá 2 modular brazo izquierdo Left arm sectional sofa 2
1	79153	Mesa centro cuadrada tapa aluminio Square coffee table aluminum top

Composición 1 Composition 1



Uds. Units	Ref.	Descripción Description
1	7704504	Base 92 x 92 + Asiento Individual + Resp. Single + Brazo Dcho. Base 92 x 92 + Single Seat & Back + Right Arm
1	7704906	Base 246 x 92 + Asiento y Resp. Doble + Asiento y Resp. Single + Brazo Dcho. Base 246 x 92 + Double Seat & Back + Single Seat & Back + Right Arm
1	7704503	Base 92 x 92 + Asiento Individual + Resp. Single + Brazo Izq. Base 92 x 92 + Single Seat & Back + Left Arm
1	77051	Mesa tapa teca sin cristal Teak Top Table without Glass
1	77055	Mesa tapa teca sin cristal Teak Top Table without Glass
1	77056	Mesa tapa teca sin cristal Teak Top Table without Glass

Composición 2 Composition 2



Uds. Units	Ref.	Descripción Description
1	7704708	Base 184 x 92 + Asiento Doble + Resp. Doble + Brazo Dcho. Base 184 x 92 + Double Seat & Back + Right Arm
1	7704501	Base 92 x 92 + Asiento Single + Resp. Single Dcho. Base 92 x 92 + Right Single & Back
1	77050	Mesa tapa teca sin cristal Teak Top Table without Glass

Composición 3 Composition 3



Uds. Units	Ref.	Descripción Description
1	7704902	Base 246 x 92 + Asiento Doble + Resp. Doble Izq. Base 246 x 92 + Left Double Seat & Back
1	7704903	Base 246 x 92 + Asiento Doble + Resp. Doble + Brazo Dcho. Base 246 x 92 + Double Seat & Back + Right Arm
1	7704909	Base 246 x 92 + Asiento y Resp. Doble + Asiento Single + Brazo Izq. Base 246 x 92 + Double Seat and Back + Single Seat + Left Arm
1	7704701	Base 184 x 92 + Asiento Doble + Resp. Doble Dcha. Base 184 x 92 + Right Double Seat & Back
1	77053	Mesa tapa teca sin cristal Teak Top Table without Glass
1	77054	Mesa tapa teca sin cristal Teak Top Table without Glass

Composición 4 Composition 4



Uds. Units	Ref.	Descripción Description
1	7704708	Base 184 x 92 + Asiento Doble + Resp. Doble + Brazo Dcho. Base 184 x 92 + Double Seat & Back + Right Arm
1	7704905	Base 246 x 92 + Asiento y Resp. Doble + Asiento y Resp. Single + Brazo Izq. Base 246 x 92 + Double Seat & Back + Single Seat & Back + Left Arm
1	77053	Mesa tapa teca sin cristal Teak Top Table without Glass

Composición 5 Composition 5



Uds. Units	Ref.	Descripción Description
1	7704907	Base 246 x 92 + Asiento y Resp. Doble + Asiento y Resp. Single Izq. Base 246 x 92 + Left Double Seat & Back + Single Seat & Back
1	7704904	Base 246x92 + Asiento Doble + Resp. Doble + Brazo Izq. Base 246 x 92 + Double Back + Left Arm
1	7704708	Base 184 x 92 + Asiento Doble + Resp. Doble + Brazo Dcho. Base 184 x 92 + Double Seat & Back + Right Arm
1	77055	Mesa tapa teca sin cristal Teak Top Table without Glass
2	77056	Mesa tapa teca sin cristal Teak Top Table without Glass

Composición 6 Composition 6



Uds. Units	Ref.	Descripción Description
1	7704906	Base 246 x 92 + Asiento y Resp. Doble + Asiento y Resp. Single + Brazo Dcho. Base 246 x 92 + Double Seat & Back + Single Seat & Back + Right Arm
1	7704905	Base 246 x 92 + Asiento y Resp. Doble + Asiento y Resp. Single + Brazo Izq. Base 246 x 92 + Double Seat & Back + Single Seat & Back + Left Arm
1	77052	Mesa Tapa Teca sin Cristal Teak Top Table without Glass
2	77050	Mesa Tapa Teca sin Cristal Teak Top Table without Glass

Composición 7 Composition 7



Uds. Units	Ref.	Descripción Description
3	7704500	Base 92 x 92 + Asiento Single + Resp. Single Base 92 x 92 + Single Seat & Back
1	7704504	Base 92 x 92 + Asiento Single + Resp. Single + Brazo Dcho. Base 92 x 92 + Single Seat & Back + Right Arm.
1	7704503	Base 92 x 92 + Asiento Single + Resp. Single + Brazo Izq. Base 92 x 92 + Single Seat & Back + Left Arm.

Composición 8 Composition 8



Uds. Units	Ref.	Descripción Description
1	7704504	Base 92 x 92 + Asiento Single + Resp. Single + Brazo Dcho. Base 92 x 92 + Single Seat & Back + Right Arm.
2	7704500	Base 92 x 92 + Asiento Single + Resp. Single Base 92 x 92 + Single Seat & Back
1	7704400	Base 92 x 92 + Asiento Puf / Ottoman Seat

HERITAGE

Composición 1 Composition 1



Uds. Units	Ref.	Descripción Description
1	78542	Sofá 3 Mod. Brazo Derecho Right Arm Sectional Sofa 3
1	78551	Rinconera Corner
1	78546	Sofá 2 Mod. Brazo Izquierdo Left Arm Sectional Sofa 2
1	78553	Mesa Teca Centro Cuadrada Teak Square Coffee Table

Composición 2 Composition 2



Uds. Units	Ref.	Descripción Description
4	78545	Sillón Lounge Chair
1	78544	Sofá 2 Mod. Brazo Derecho Right Arm Sectional Sofa 2
1	78546	Sofá 2 Mod. Brazo Izquierdo Left Arm Sectional Sofa 2
2	78553	Mesa Teca Centro Cuadrada Teak Square Coffee Table
2	78556	Mesa Teca Rincón Cuadrada Teak Square Side Table

Composición 3 Composition 3



Uds. Units	Ref.	Descripción Description
1	78542	Sofá 3 Mod. Brazo Derecho Right Arm Sectional Sofa 3
1	78543	Sofá 3 Mod. Brazo Izquierdo Left Arm Sectional Sofa 3
2	78553	Mesa Teca Centro Cuadrada Teak Square Coffee Table

Finishes and
maintenance

Shintotex®
Advanced synthetic fibers

Es la fibra sintética para muebles de exterior inspirada en la naturaleza y perfeccionada técnicamente hasta alcanzar el máximo nivel de confort, funcionalidad y durabilidad. El Shintotex está compuesto por PP y PE más componentes catalizadores como filtros UV, pigmentos, aditivos anti-estáticos y elementos plastificantes.

Características técnicas

Resistencia a cambios climatológicos.
Resistencia a agentes químicos abrasivos.
Resistencia a rotura y deterioro por el uso.
Alta flexibilidad.
Total reciclaje.

Características estéticas

Calidez y apariencia natural.
Tacto agradable.
Variedad de texturas y trenzados.
Fácil limpieza.
Mayor ligereza.

Limpieza y mantenimiento

Pasar cepillo de cerdas suaves sobre el tejido para eliminar el polvo o utilizar solución jabonosa de PH neutro para la limpieza de residuos o manchas. Evitar el contacto con productos abrasivos (lejías, cloro, aceites, productos con ácidos o sustancias corrosivas en su composición).

This is a synthetic fiber for outdoor furniture, inspired by nature and perfected by technology to achieve maximum comfort, functionality and durability. Shintotex is made of PP and PE, as well as catalysts, such as UV filters, pigments, additives, anti-static agents and plasticisers.

Technical features

Resistant to changing weather conditions.
Resistant to abrasive chemical agents.
Resistant to breakage and to wear and tear.
Highly flexible.
Fully recyclable.

Aesthetic features

Warm, natural appearance.
Pleasant to the touch.
Variety of textures and braids.
Easy to clean.
Lighter weight.

Maintenance and cleaning

Use a soft-bristled brush to remove any dust from the weave. Also, a soapy solution of neutral PH can be used to clean any residue or marks. Avoid contact with abrasive products (bleach, chlorine, oils, products containing corrosive acids or substances).



Round 3-4 mm O3 Tostado / Toasted

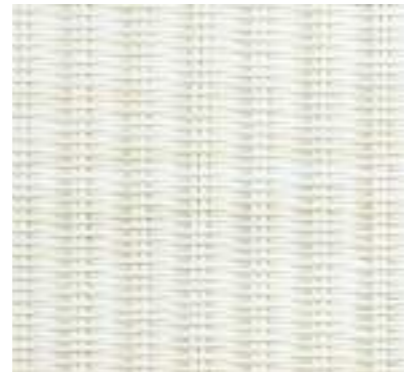

Round 3-4 mm 36 Marfil / Ivory



Flat oval 6mm 36 Marfil / Ivory



Flat oval 6mm O3 Tostado / Toasted

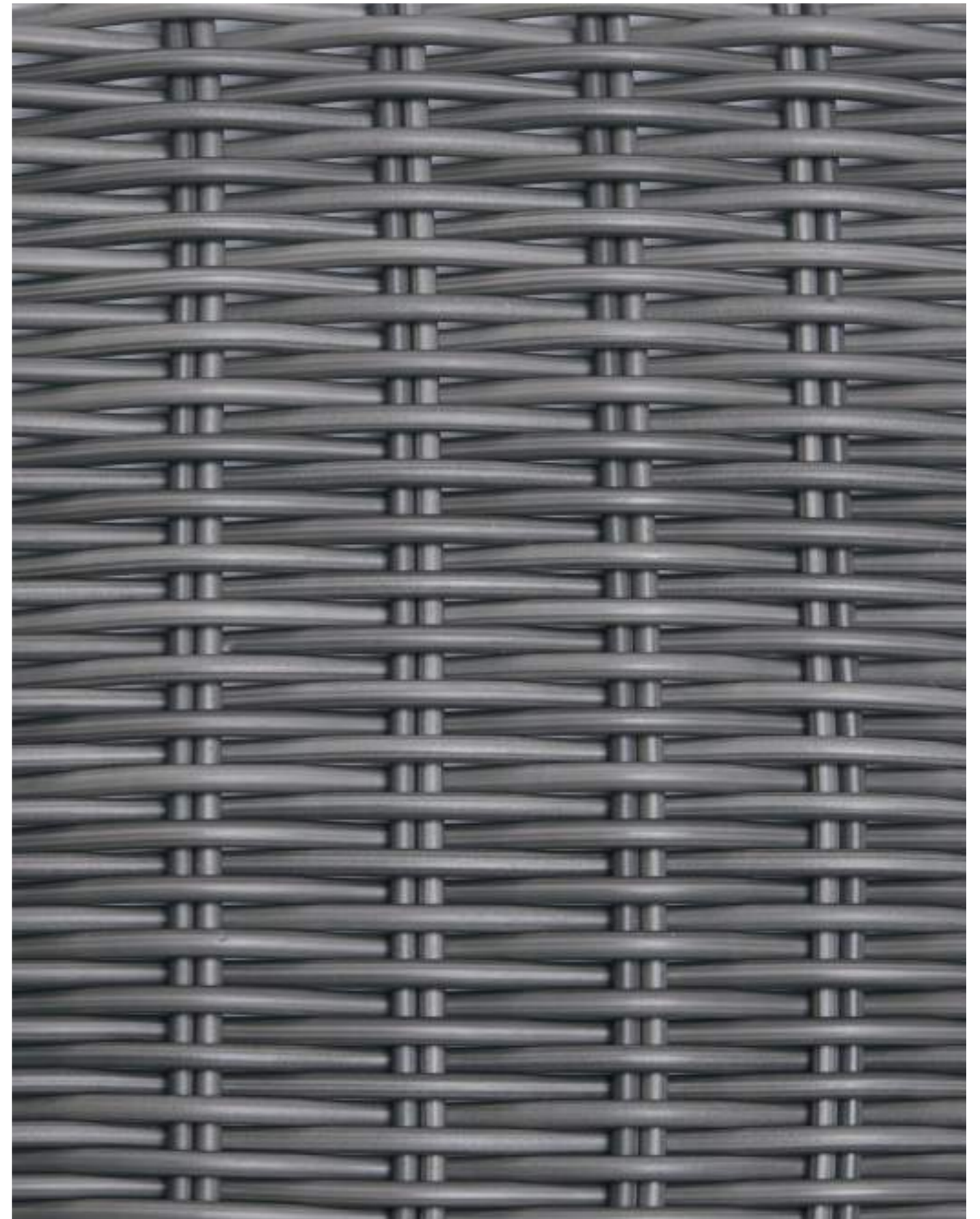

Round Ø6 mm Ash Grey

**Cuerda
Rope
Ø8 mm**

Cuerda elaborada en hilo de poliéster, totalmente apta para exteriores. Ofrece gran resistencia a la luz (7 sobre 8) y a la intemperie.

Limpieza y mantenimiento

Utilizar solución jabonosa de PH neutro para la limpieza de residuos o manchas. Evitar el contacto con productos abrasivos (lejías, cloro, aceites, productos con ácidos o sustancias corrosivas en su composición).

Polyester rope for outdoor use. Offers great lightfastness (7 out of 8) and weather resistance.

Maintenance and cleaning

A soapy solution with a neutral pH can be used to clean residue or marks. Avoid contact with abrasive products (bleach, chlorine, oils, products containing corrosive acids or substances).

**Cuerda
Rope
Ø4 mm**

Tanto el ánima como el recubrimiento del cordón es de polipropileno para conseguir una mayor solidez a la luz e intemperie. Además, lleva un filtro de color para mayor fijación.

Limpieza y mantenimiento

Utilizar solución jabonosa de pH neutro para la limpieza de residuos o manchas. Evitar el contacto con productos abrasivos (lejías, cloro, aceites, productos con ácidos o sustancias corrosivas en su composición).

Both the rope itself and its coating are made from polypropylene to ensure greater resistance to light and weather. It also includes a colour filter for greater fixing.

Maintenance and cleaning

A soapy solution with a neutral pH can be used to clean any dirt or marks. Avoid contact with abrasive products (bleach, chlorine, oils, products containing acids or corrosive substances).

Khai Collection



Turrón / Nougat



Taupe / Taupe



Negro / Black

Summer Collection



Beige / Beige

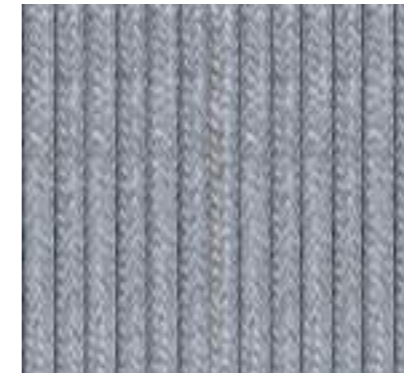

Gris Perlado / Pearl Grey



Grafito / Graphite

Weave Collection



61 Blanco Mineral - Turrón / Mineral White - Nougat



60 Gris - Taupe / Grey - Taupe



59 Negro / Black

City & Legacy Collection

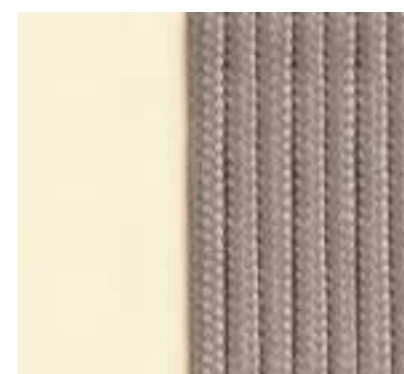

34 Blanco Mineral - Beige / Mineral White - Beige



74 Arena-Gris Perlado / Sand - Pearl Grey
Disponibile solo para colección City / Only available for the City Collection



56 Gris Metalizado - Grafito / Gunmetal Grey - Graphite

Cuerda Sintética Synthetic Rope

Ø4 mm

Paralel Collection

Cuerda sintética para muebles de exterior compuesta de polietileno de alta densidad. Cuenta con un alto nivel de confort, funcionalidad y durabilidad.

Características técnicas

Resistencia a cambios climatológicos.
Resistencia a rotura y deterioro por el uso.
Alta flexibilidad.
Total reciclaje.

Características estéticas

Calidez y apariencia natural.
Tacto agradable.
Fácil limpieza.
Mayor ligereza.

Limpieza y mantenimiento

Pasar cepillo de cerdas suaves sobre la cuerda para eliminar el polvo, o utilizar solución jabonosa de PH neutro para la limpieza de residuos o manchas. Evitar el contacto con productos abrasivos (lejías, cloro, aceites, productos con ácidos o sustancias corrosivas en su composición).

Synthetic rope for outdoor furniture. A high-density polyethylene compound that offers a high level of comfort, functionality and durability.

Technical features

Resistant to changing weather conditions.
Resistant to breakage and to wear and tear.
Highly flexible.
Totally recycled.

Aesthetic features

Warm, natural appearance.
Pleasant to the touch.
Easy to clean.
Lighter weight.

Cleaning and maintenance

Brush the rope with a soft-bristled brush to remove any dust, or use a soapy solution with a neutral pH to clean any residue or marks. Avoid contact with abrasive products (bleach, chlorine, oils, products containing acids or corrosive substances).



Teca Natural Natural Teak



Madera de teca natural de grado A con certificado FSC® C188181

POINT utiliza madera teca de grado A de origen asiático, procedente de bosques sostenibles de talas controladas. La teca está clasificada como la madera más premium del planeta y, por lo tanto, la más adecuada para los muebles de exterior.

Es extremadamente duradera, estable, impermeable y resistente a la intemperie. Esto se debe a los altos niveles de aceites naturales, dando como resultado una mínima absorción de la humedad y una gran estabilidad. Además, esta madera es muy resistente a los hongos, así como a los ataques de parásitos e insectos.

La teca se dilata y contrae con los cambios climáticos. La contracción de la madera puede provocar grietas finas en las juntas de ensamblaje o en la propia veta de la madera. Esto no afecta a la integridad estructural del armazón.

En POINT no aplicamos ningún “acabado” a nuestra teca. Toda nuestra teca tiene un acabado natural sin ningún tratamiento.

Con el tiempo, los muebles de teca que están al sol, lluvia, humedad, etc. pueden volverse de un color gris. Esto es debido a un proceso de oxidación superficial que protege naturalmente la madera y hace que adquiera una coloración gris plata. Este proceso es estético y no daña la resistencia ni la calidad de la madera.

Dependiendo de las condiciones ambientales, la coloración grisácea natural o el desgaste causado por factores

Grade-A natural teak wood with FSC® C188181 certified

POINT uses grade-A Asian teak wood sourced from carefully managed sustainable forests. Teak is considered the most premium wood on Earth and, therefore, the most suitable for outdoor furniture. It is extremely hard-wearing, stable, waterproof and weather-resistant. This is due to its high level of natural oils, resulting in minimal moisture absorption and great stability. This wood is also highly resistant to fungi and attacks by parasites and insects.

Teak expands and contracts with changes in climate. Shrinking of the wood can result in hairline cracks in the assembly joints or the grain of the wood itself. This does not affect the structural integrity of the frame's construction

At POINT we do not apply any “finish” to our teak. All our teak is untreated and has a natural finish.

Over time, teak furniture that is exposed to sun, rain, humidity, etc. can turn a silver-grey colour. This is due to a process of surface oxidation that naturally protects the wood and gives it a grey hue. This process is merely aesthetic and does not affect the strength or quality of the wood.

Depending on the environmental conditions, this natural greying or weathering may be noticed after a few weeks. In drier climates, it will take several months for the teak to be affected.



Teca Natural / Natural Teak

climatológicos pueden notarse después de unas semanas. En climas más secos, la teca tardará varios meses en verse afectada. La aparición de aceite en la superficie de los muebles de teca es algo normal. Los aceites naturales presentes en la teca son los que la convierten en la mejor madera para muebles de exterior. De hecho, un alto contenido en aceite es un indicador de una madera de alta calidad. Sin estos aceites, la madera no sobreviviría a temperaturas y humedad extrema a la que normalmente están expuestos los muebles de exterior.

Los aceites y pigmentos dentro de la capa superficial de la teca comenzarán a lavarse gradualmente durante la exposición a las primeras lluvias. Este es un proceso natural y el aceite puede desprenderse durante los primeros 2 - 3 meses, según el entorno en el que se coloquen los muebles.

Evite colocar los muebles nuevos de teca en espacios exteriores con pavimentos de piedra porosa de color claro hasta que el proceso de expulsión de aceite haya disminuido. Del mismo modo, evite dejar cojines de colores claros sobre o cerca de los muebles de teca durante este proceso: los tejidos manchados con aceite de teca natural se pueden limpiar con agua y jabón neutro. La cantidad de aceite que sale de la teca durante los primeros meses será mayor y, por lo tanto, es más probable que cause manchas en las superficies y tejidos. Este es un proceso natural que no puede ser previsto.

Debido a que la teca es una madera naturalmente aceitosa, no es adecuado pintar ni barnizar. Cualquier pintura o barniz aplicada no se adherirá correctamente a la superficie y después de un tiempo comenzará a desprenderse. No recomendamos el uso de ningún aceite de madera en la teca. La teca ya es una madera naturalmente "aceitosa" y la adición de más aceite no agrega ninguna protección adicional. Si se incluye aceite de manera adicional, comenzará a crearse moho en las capas superficiales y la teca se volverá negra gradualmente; coloración que sólo puede eliminarse con un lijado agresivo.

The appearance of oil on the surface of teak furniture is normal. It is the natural oils in teak that make it the best wood for outdoor furniture. In fact, a high oil content is an indicator of high-quality wood. Without these oils, the wood would not survive the extreme temperatures and humidity to which outdoor furniture is normally exposed.

The oils and pigments in the surface layer of the teak will gradually begin to wash away the first few times it is exposed to rain. This is a perfectly natural process and it can secrete oil for the first 2 - 3 months, depending on where the furniture is placed.

Do not place new teak furniture on light coloured porous stone patio surfaces until the oil secretion process has decreased somewhat. Similarly, avoid leaving cushions covered with light coloured fabrics on or near teak furniture during this process: fabric stained with natural teak oil can be cleaned with neutral soap and water. The amount of oil that comes out of the teak will be greater during the first few months and, therefore, it is more likely to stain surfaces and fabrics. This is a natural process that cannot be foreseen.

Wasps can occasionally attack the teak surface to make their nests, usually in the spring and early summer. There is no way to prevent this from happening, other than by removing their nests and scaring the wasps away.

Because teak is a naturally oily wood, it should not be painted or varnished. Any paint or varnish applied will not adhere properly to the surface and will soon begin to peel. We do not recommend using any wood oil on teak. Teak is already a naturally "oily" wood and the addition of more oil does not confer any additional protection. If oil is added, mould will begin to build up in the surface layers and the teak will gradually turn black, which can only be removed by aggressive sanding.

Limpieza y mantenimiento

A pesar de ser un excelente material para los muebles de exterior, su tratamiento y mantenimiento son indispensables para conservar su belleza.

Si usted quiere mantener el color plateado natural, POINT recomienda el uso del TEAK CLEANER para limpiar y abrillantar la madera. Para mantener la teca con el mismo aspecto que tiene cuando está recién sacada de la caja, use primero el limpiador y abrillantador TEAK CLEANER para restaurar el color y aplique, posteriormente, el protector TEAK PROTECTOR EcoSafe para mantener y conservar el marrón dorado durante más tiempo. Este producto no es un aceite y está elaborado a base de agua, sin disolventes. Ninguno de estos dos productos afecta a la resistencia y longevidad de los muebles, únicamente a su apariencia.



Teak cleaner

Modo de empleo:

1. Antes de emplear el TEAK CLEANER, se debe utilizar una protección para los ojos y guantes de goma. Antes de empezar proteja la superficie en donde se va a trabajar.
2. Primero mojar el mueble con agua.
3. Agite el TEAK CLEANER antes de usar.
4. Aplique el TEAK CLEANER con un paño suave o una esponja. Dejar penetrar durante 3 minutos.
5. Cepille el mueble para limpiarlo con una almohadilla de fregar en dirección al veteado.
6. Lave bien el mueble con agua.
7. Para un color prolongado, deje secar el mueble y trátelo con TEAK PROTECTOR.

Maintenance and cleaning

Despite being an excellent material for outdoor furniture, its treatment and maintenance are essential to preserve its beauty.

If you want to keep the natural silver colour, POINT recommends using the TEAK CLEANER to clean and polish the wood. To keep the teak looking like it did when it was new, first use the TEAK CLEANER to clean and polish and to restore the colour, then apply EcoSafe TEAK PROTECTOR to maintain and preserve its golden brown colour for longer. This is not an oil; it is a water-based, solvent-free product. Neither of the two products affects the strength and longevity of the furniture, only its appearance.

Teak cleaner

Directions for use:

1. Before using the TEAK CLEANER, put on eye protection and rubber gloves. Before you start, protect the surface where you are going to work.
2. First wet the furniture with water.
3. Shake the TEAK CLEANER before use.
4. Apply the TEAK CLEANER with a soft cloth or a sponge. Allow to penetrate for 3 minutes.
5. Use a scouring pad to clean the furniture, brushing it in the direction of the wood's grain.
6. Wash the furniture thoroughly with water.
7. For long-lasting colour, let the furniture dry and treat it with the TEAK PROTECTOR.



Teak protector

¿Por qué es mucho mejor que el TEAK SELLADOR?

1. Mantiene el color marrón dorado de la teca durante más tiempo:
 - Hasta 4 veces más que el aceite de teca.
 - Hasta el doble de largo que los selladores de teca.
2. Es respetuoso con el medio ambiente porque es 100% con base de agua. Sin humos tóxicos. No es inflamable. EcoSafe.
3. Es rápido y fácil de aplicar.
4. No es un aceite, no es grasiento.
5. Es resistente al moho y evita manchas negras en la teca.

Instrucciones de uso:

1. Antes de utilizar el TEAK PROTECTOR se debe utilizar protección en los ojos y guantes de goma. Cubra el suelo debajo de su área de trabajo antes de comenzar.
2. La teca gris o la teca tratada con aceite de teca deben limpiarse primero con TEAK CLEANER.
3. Teca nueva: limpie con TEAK CLEANER para eliminar algunos de los aceites naturales de la teca o también puede dejar a la intemperie durante 2 semanas en el exterior antes del tratamiento.
4. Si la madera limpia está áspera, lijar ligeramente antes de tratar con TEAK PROTECTOR. Asegúrese de que la teca esté 100% seca y sin de polvo.
5. Agitar y remover el TEAK PROTECTOR al menos un minuto antes de usar. Una agitación insuficiente puede provocar un desgaste desigual.
6. Le sugerimos que pruebe el TEAK PROTECTOR en un área pequeña primero (por ejemplo, en la parte posterior de una pata del mueble) para juzgar si el color cumple con sus expectativas.
7. Aplicar una capa muy fina de TEAK PROTECTOR uniformemente sobre el mueble con un paño sin polvo. Aplicar una segunda capa muy fina después de 30 minutos de secado.
8. Se recomienda tratar sus muebles con TEAK PROTECTOR al menos una vez al año.

Teak protector

Why is it so much better than TEAK OIL SEALER?

1. It maintains the light-brown colour of teak for a longer time:
 - Up to 4 times longer than teak oil.
 - Up to twice as long as teak sealers.
2. It is environment-friendly because it is 100% water-based; no toxic fumes; non flammable; EcoSafe.
3. It is fast and easy to apply.
4. It is not an oil, it is not greasy: clothes stay clean.
5. It is resistant to mould and prevents black spots on the teak.

Instructions for use:

1. Before using the TEAK PROTECTOR, put on eye protection and rubber gloves. Before you start, protect the surface where you are going to work.
2. Grey teak or teak treated with teak oil must first be cleaned with TEAK CLEANER.
3. In the case of new teak, first clean it with our TEAK CLEANER to remove some of the natural teak oils (or weather for 2 weeks outside before treatment).
4. If cleaned wood feels rough, sand it lightly before treating it with the Protector. Make sure the teak is completely dry and free from dust.
5. Shake and stir the TEAK PROTECTOR for at least a minute before use. Insufficient shaking can lead to uneven weathering.
6. We suggest you try the TEAK PROTECTOR on a small area first (e.g. the back of a leg) to ensure that the colour meets your expectations.
7. Apply a very thin layer of TEAK PROTECTOR evenly over the furniture with a dust-free cloth. Apply a second very thin coat after leaving to dry for 30 minutes.
8. We recommend that you treat your furniture with TEAK PROTECTOR at least once a year.

Teca Weathered Weathered Teak

La sabiduría de la edad

POINT ofrece dos tipos de acabado en sus maderas de teca, uno sin tratamiento, totalmente natural en el que el material envejece adquiriendo una hermosa pátina gris. Y, otro –weathered– en el que la madera se somete a un proceso sostenible de envejecimiento, que consiste en erosionar la veta de la madera cepillándola repetidas veces totalmente a mano hasta conseguir una textura más rústica de la veta y se le aplica un tratado con base al agua ecológico que consigue este característico efecto envejecido que adquiere la teca a la intemperie.

Este tratamiento de madera envejecida, se va desprendiendo con la exposición a los elementos. Así, la teca natural va quedando expuesta y tomando la tonalidad gris característica. El ritmo de envejecimiento del acabado varía en función del clima, la exposición y la dedicación al cuidado y mantenimiento. El proceso de envejecimiento se puede acelerar, voluntariamente, con solo dejar los muebles sin tratar o sin cubrir.

The wisdom of age

POINT offers two types of finish on its teak woods. One is untreated and completely natural, where the material takes on a beautiful grey patina as it ages. The other is weathered, where the wood undergoes a sustainable ageing process that consists of eroding the grain of the wood by repeatedly brushing it by hand to give the grain a more rustic texture. Then an ecological water-based treatment is applied to achieve this characteristic weathered look that teak takes on when exposed to the elements.

This weathered wood treatment gradually fades with exposure to the elements, leaving the natural teak exposed so that it takes on the characteristic grey tone. The rate at which the finish ages varies according to climate, exposure, and care and maintenance. The ageing process can be accelerated voluntarily by simply leaving the furniture untreated or uncovered.



Teca Weathered / Weathered Teak

TechTeak
Innovative Outdoor Teak

TechTeak es un material innovador desarrollado por POINT para muebles de exterior y minuciosamente fabricado para reproducir el aspecto cálido y natural de la teca. Su característica principal es su capacidad para resistir las condiciones climáticas más adversas sin necesidad de mantenimiento, lo que lo convierte en el mejor aliado para proyectos que requieren piezas duraderas y de alta calidad. Está compuesto por una mezcla de polímeros de última generación, aditivos antiestáticos, plastificantes y elementos catalíticos esenciales como filtros UV y pigmentos. Además, es 100% reciclable al final de su ciclo de vida, reafirmando nuestro compromiso con la sostenibilidad.

Características técnicas

Resistente a condiciones meteorológicas extremas.
Altamente duradero.
Impermeable.
Totalmente reciclable.
Incorpora un 20% de material reciclado en su composición.

Características estéticas

Aspecto cálido y natural.
Su color y estética permanecen inalterables.
Agradable al tacto.
Fácil limpieza.

Limpieza y mantenimiento

Para limpiar cualquier suciedad o marca se puede utilizar una solución jabonosa con pH neutro y una esponja de lijado suave. Evitar el contacto con productos abrasivos (lejías, aceites, productos con ácidos o sustancias corrosivas en su composición).



TechTeak

TechTeak is an innovative material developed by POINT for outdoor furniture and meticulously crafted to replicate the warm, natural look of teak. Its exceptional feature is its ability to withstand the harshest weather conditions without requiring any maintenance, providing the best solution for projects that require durable, high-quality furniture. It consists of a blend of cutting-edge polymers, anti-static additives, plasticizers, and essential catalytic elements such as UV filters and pigments. In addition, it is 100% recyclable at the end of its life cycle, reaffirming our commitment to sustainability.

Technical features

Resistant to extreme weather conditions.
Highly durable.
Waterproof resistant.
Fully Recyclable.
It incorporates 20% recycled material in its composition.

Aesthetic features

Warm, natural appearance.
Its color and aesthetics remain unaltered.
Soft and smooth texture.
Easy to clean.

Maintenance and cleaning

A soapy solution with a neutral pH and a soft sanding sponge can be used to clean any dirt or mark. Avoid contact with abrasive products (bleach, oils, products with acids or corrosive substances in their composition).



Porcelánico Porcelain

Se trata de un material porcelánico elaborado de 12 mm de espesor. Características técnicas: Impermeable y resistente a líquidos, con un nivel de absorción próximo a cero. Resistente al rayado y a la abrasión gracias a la dureza de su superficie. No se quema en contacto con el fuego ni emite humo ni sustancias tóxicas al ser sometido a altas temperaturas. Resistente a cualquier tipo de agente químico de limpieza. No desprende sustancias nocivas. Es totalmente apto para el contacto con los alimentos. Certificado NSF. Siendo 100% natural, los colores no se desvirtúan cuando el material se expone al sol o a condiciones meteorológicas extremas. No desprende ninguna sustancia nociva para el entorno. Hasta un 52% de material reciclado en cada tabla. 100% reciclable. 30 kg/m² en la tabla de 12 mm. Módulo de rotura elevado. Resistente a altas cargas de presión y peso.

This is a 12-mm thick porcelain material. Technical characteristics: Waterproof and resistant to liquids, with an absorption level close to zero. Scratch and abrasion resistant thanks to the hardness of the surface. No combustion takes place in contact with fire and no smoke or toxic substances are released when it is subjected to high temperatures. Resistant to any type of chemical or cleaning agent. No dangerous substances are given off. It is totally apt for contact with foodstuffs. NSF certified. As it is 100% natural, the colours do not fade when exposed to sunlight or subjected to extreme weather conditions. No dangerous substances that may harm the environment are given off. Each board contains up to 52% recycled material. 100% recyclable. 30 kg/m² in a 12 mm board. Highly resistant to breakage. Resistant to high pressures and loads.

Limpieza y mantenimiento

Tiene una limpieza fácil ya que no pueden penetrar en el material los restos de comida y residuos que se depositen por lo que garantizan una buena higiene. Para la mayoría de los casos, sólo bastará con un paño húmedo para limpiarlo. Use un paño de microfibra para quitar el polvo de la superficie. Se puede lavar con agua tibia, a la cual se le puede agregar un detergente en la dosis de uso recomendado por el fabricante. (Deben evitarse productos que contengan ácido fluorhídrico y sus derivados). Enjuagar con agua tibia y secar con bayetas o algo similar.

Maintenance and cleaning

Easy to clean, as traces of food and other residues on the surface cannot penetrate the material, thus offering enhanced hygiene; in most cases, it is sufficient to wipe the surface clean with a damp cloth. Use a microfibre cloth to dust the surface. To wash, use lukewarm water; a detergent may be added according to the dosage recommended by the manufacturer (products containing hydrofluoric acid and its derivatives should be avoided). Rinse with lukewarm water and dry with a clean cloth.



87 Gris Ocre / Ochre Grey



85 Blanco Roto Veteado / Veined Off White



82 Gris Lava / Lava Grey



86 Gris Basalto / Basalt Grey



81 Blanco Natural / Natural White

Compacto HPL

Es el material de las tapas de las mesas de algunas colecciones. Se trata de tablero compacto de 10 mm de espesor en calidad standard (CGS) termoendurecido a alta presión en formato 4200x1600 mm con el núcleo compuesto de resinas fenólicas y superficies decorativas impregnadas en resinas melamínicas.

Limpieza y mantenimiento

Las superficies de compacto deben limpiarse con regularidad pero no requieren ningún mantenimiento especial, solo un paño húmedo con agua templada o detergente suave. Se pueden usar perfectamente casi todos los productos de limpieza o desinfectantes domésticos siempre y cuando estos no sean abrasivos o altamente alcalinos.

This is the material used for the table tops of some collections. It is a 10-mm thick, compact board in standard quality (CGS), which was thermoset at high pressure in a 4200x1600 mm mould, with a core made of phenolic resins and decorative surfaces that are impregnated with melamine resins.

Maintenance and cleaning

Surfaces made out of HPL should be cleaned regularly and do not require any special maintenance; just wipe with a damp cloth that has been previously soaked in lukewarm water with a gentle detergent. Almost all kinds of cleaning products can be used without any problem, as long as they are not abrasive or highly alkaline.



G1 Beige / Beige



G1 Negro / Black



G2 Blanco Monocolor / Solid White



G2 Blanco Marmolizado / Marbled White



G2 Madera / Wood



G2 Taupe Monocolor / Solid Taupe

Hormigón Concrete

Se trata de una estudiada mezcla de hormigón de alta calidad reforzada y sellada con imprimación superficial de resina acrílica en base acuosa, libre de plastificantes y disolventes, para garantizar el máximo nivel de rendimiento, resistencia y durabilidad. Está fabricado con cemento ECO tipo II/A-LL 52,5 R, de resistencia elevada y producido con una reducción de emisiones directas de CO2 superior al 15%. Al final de su ciclo de vida es 100% reciclable.

Características técnicas

Resistencia a cambios climatológicos adversos.
Gran durabilidad.
Estabilidad.
Resistencia a la abrasión.
Resistente al moho y las plagas de insectos.

Características estéticas

Textura mate.
Su color y estética permanecen inalterables.
Fácil limpieza.

Limpieza y mantenimiento

Puede utilizarse una solución jabonosa con pH neutro para eliminar cualquier mancha o marca. Evite productos químicos agresivos o cepillos abrasivos que puedan dañar el acabado. Utilice fundas protectoras durante periodos prolongados sin uso para proteger sus muebles de la intemperie.



Hormigón / Concrete

Shaped using a special blend of high-quality concrete reinforced and sealed with a surface primer of water-based acrylic resin, free of plasticizers and solvents, ensuring the highest level of performance, strength and durability. It is made with high-strength ECO cement type II/A-L 52.5 R, produced with a direct reduction of CO2 emissions of more than 15%. It is 100% recyclable at the end of its life cycle.

Technical features

Resistant to extreme weather conditions.
Highly durable.
Stability.
Resistant to mold, mildew, and insect damage.

Aesthetic features

Sleek and modern design.
Subtle texture adds a visual interest and tactile dimension.
Its color and aesthetics remain unaltered.
Easy to clean.

Maintenance and cleaning

A soapy solution with a neutral pH can be used to remove any stains or marks. Avoid harsh chemicals or abrasive brushes that could damage the finish. Use protective covers during extended periods of non-use to shield your furniture from the elements.

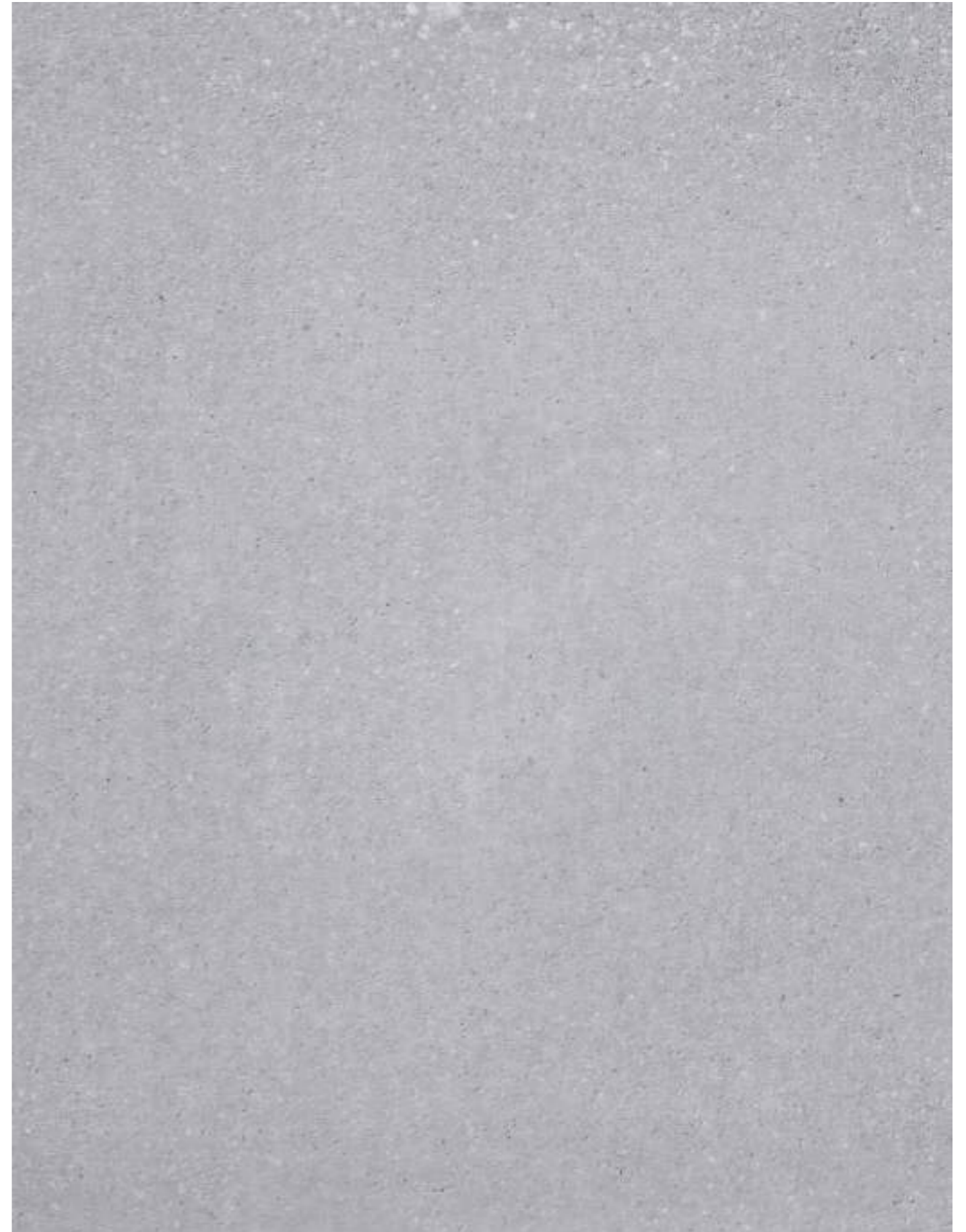

**Aluminio
pintado en polvo
Powder coated
aluminum**

Se aplica un recubrimiento en polvo que proporciona una gran durabilidad y estabilidad del color en exteriores. Está compuesto por resinas de poliéster, pigmentos y aditivos, libre de TGIC.

Limpieza y mantenimiento

Utilizaremos bayetas suaves o esponjas que no rayen la superficie y agua con jabón o detergentes neutros diluidos en agua; nunca productos abrasivos. Después se enjuagará con agua limpia y se secará con un paño, para evitar que el detergente afecte al material.

A powder coating is applied to ensure durability and color stability for outdoors. It is composed of polyester resins, pigments and additives, free of TGIC.

Maintenance and cleaning

Use soft cloths or sponges that will not scratch the surface with soap and water or neutral detergents diluted in water; never use abrasive products. Then rinse with clean water and dry with a cloth to prevent the detergent from affecting the material.



73 Verde Ficus / Green Ficus

34 Blanco Mineral / Mineral White

70 Blanco Nieve / White Snow

56 Gris Metalizado / Gunmetal Grey

59 Negro / Black



72 Terracota / Terracotta

71 Azul Cielo / Blue Sky

60 Gris Taupe / Taupe Grey

75 Óxido / Rust

74 Arena / Sand

Funda de cubrir

En POINT recomendamos proteger los muebles de exterior con medidas simples y mejorar así su durabilidad. Para ello, creamos la Protective Cover, una funda protectora especial, disponible en color beige, hecha de poliéster con lacado acrílico. Es resistente al agua y cuenta con un tratamiento fungicida en el interior. Además, es repelente a la suciedad y resistente al frío, al calor y a la intemperie. Cada pieza cuenta con su propia funda. Además, tiene un cordón que permite ajustar la funda al mueble, alrededor de la base, para que el viento no pueda levantarla. Para obtener mejores resultados, es conveniente que los muebles, cojines y cuadrantes estén secos antes de cubrirlos para evitar humedad y manchas de moho.

Protective cover

At POINT we recommend simple measures to protect outdoor furniture and make it more durable. For this purpose, we created the Protective Cover, a special protective sheet, available in beige and made from polyester with acrylic lacquer. It is waterproof and treated with a fungicide on the inside. It also repels dirt and is heat, cold and weather resistant. Each piece comes with its own cover. It also includes a tie so you can adjust the cover to the furniture around the base to secure it against the wind. For the best results, the furniture and cushions should be dry before they are covered in order to avoid moisture and mould stains.



Fabrics

Composición: 100% Acrílico teñido en masa
Ancho: 160cm
Acabado: hidrófugo con tratamiento antimanchas.
Solidez a la luz: 7/8
Garantía: 5 años
Tolerancia: valores susceptibles de tolerancia de +/- 5%

Composition: 100% solution dyed acrylic
Width: 160 cm
Finish: water repellent with a stain resistant treatment.
Light fastness: 7/8
Warranty: 5 years
Tolerance: values subject to +/- 5% tolerance

Limpieza y mantenimiento
Maintenance and cleaning

Eliminar la suciedad mediante cepillado o aspirado suave del tejido. Lavar a temperatura máxima de 30º y jabón neutro. No utilizar disolventes ni detergentes abrasivos. No utilizar secadora. Planchado máximo a 150º. No admite lavado en seco.

Remove dirt by softly brushing or vacuuming the fabric. Wash at 30º max. with a mild soap. Do not use solvents or abrasive detergents. Do not tumble dry. Iron up to 150º max. Do not dry clean.

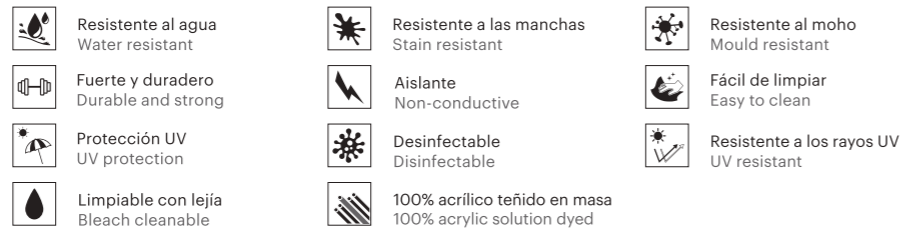

Composición: Composite PVC – fibras sintéticas
Ancho: 180cm
Garantía: 5 años
Reciclabilidad: 100% por el sistema Taxyloop
Sistema de gestión de calidad: ISO 9001
Sistema de gestión medioambiental: ISO 14001

Composition: Composite PVC-synthetic fibres
Width: 180 cm
Warranty: 5 years
Recyclability: 100% by Taxyloop method
Quality system: ISO 9001
Environmental system: ISO 14001

Limpieza y mantenimiento
Maintenance and cleaning

Quitar el polvo al tejido con un aspirador o un cepillo suave no metálico. Lavar con un cepillo suave o una esponja utilizando agua jabonosa. Aclarar abundantemente con agua. Dejar que se seque bien el tejido al aire libre en posición desplegada. Si el tejido puede desprenderse de su soporte, la limpieza puede realizarse a máquina a una temperatura no superior a 40ºC.

Remove dust from the fabric with a vacuum cleaner or soft, non-metallic brush. Wash with a soft brush or a sponge, using soapy water. Rinse copiously with water. Allow the fabric to air dry completely, well spread out. If the textile can be removed from its base, it may be machine-washed at a temperature no higher than 40ºC.

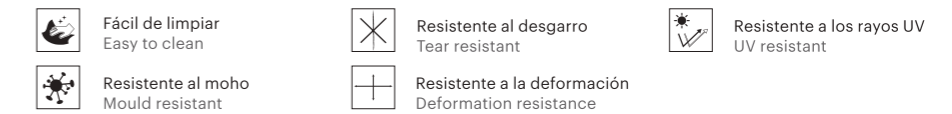

Composición: 78% Acrílico tintado en masa + 22% Acrílico tintado en masa reciclado
Ancho: 160cm
Solidez a la luz: 7/8 UNE EN ISO 105-B02:2014
Garantía: 5 años
Tolerancia: valores susceptibles de tolerancia de +/- 5%

Composition: 78% Solution Dyed Acrylic + 22% Recycled Solution Dyed Acrylic
Width: 160 cm
Light fastness: 7/8 UNE EN ISO 105-B02:2014
Warranty: 5 years
Tolerance: values subject to +/- 5% tolerance

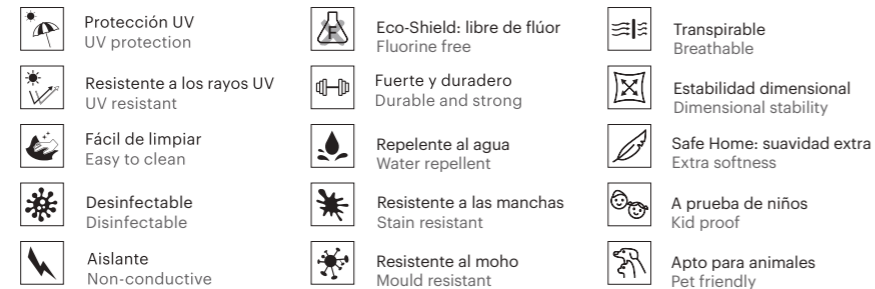

Composición: 100% acrílico teñido en masa
Ancho: 140cm - 55”
Peso: 900gr/m - 29oz/yd
Solidez a la luz: 7/8
Garantía: 5 años

Composition: 100% solution-dyed acrylic
Width: 140 cm - 55”
Weight: 900gr/m - 29oz/yd
Light fastness: 7/8
Warranty: 5 years

Limpieza y mantenimiento
Maintenance and cleaning

Recomendamos eliminar las manchas y los derrames inmediatamente en cuanto se produzcan, secando la superficie de los tejidos con una esponja o paño limpio, agua tibia y detergente suave. Aclare a fondo con agua limpia. Deje secar al aire. La lejía no afectará a la coloración de la fibra acrílica teñida en masa y, por lo tanto, es aceptable para eliminar manchas difíciles, si se diluye adecuadamente.

We recommend removing stains and spills immediately as they occur, blotting the surface of the fabrics with a clean sponge or cloth, lukewarm water and mild detergent. Rinse thoroughly with clean water. Let air dry. Chlorine bleach will not affect the coloration of the solution-dyed acrylic fiber and is therefore acceptable for stubborn stain removal, if properly diluted.



Composición: 100% acrílico
teñido en masa
Ancho: 140cm - 55"
Solidez a la luz: 7/8
Garantía: 5 años
Resistencia al mojado superficial:
100 UNE-EN ISO 4920
Comportamiento al fuego:
Class 1 NFPA 260

Composition: 100%
solution-dyed acrylic
Width: 140 cm - 55"
Light fastness: 7/8
Warranty: 5 years
Resistance to surface wetting:
100 UNE-EN ISO 4920
Flame retardant: Class 1 NFPA 260

Limpieza y mantenimiento
Maintenance and cleaning

En el lavado a mano no utilizar cepillos duros. Utilizar agua templada junto una solución jabonosa. Aclarar abundantemente y dejar secar al aire. Se pueden lavar a máquina en el modo sintético suave. Se pueden usar blanqueadores. El planchado reactiva el acabado.

When washing by hand, do not use hard brushes. Use lukewarm water together with a soap solution. Rinse thoroughly and allow to air dry. Machine washable in soft synthetic mode. Bleach can be used. Ironing reactivates the finish.

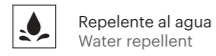

Repelente al agua
Water repellent



Transpirable
Breathable



Resistente a los rayos UV
UV Resistant



Fácil de limpiar
Easy to clean



Máxima Solidez del Color
Maximum Color Fastness



100% acrílico teñido en masa
100% acrylic solution dyed

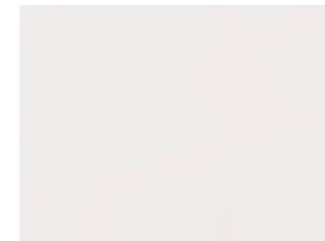

G1 22 20000 C. Martindale



G1 21 20000 C. Martindale



G1 1101 20000 C. Martindale

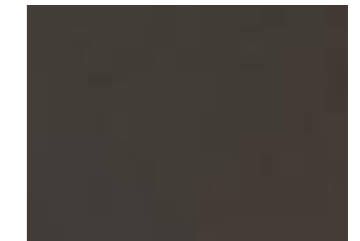

G1 1103 20000 C. Martindale



G2 1284 25000 C. Martindale



G2 1285 25000 C. Martindale



G2 1086 25000 C. Martindale



G2 1088 20000 C. Martindale



G2 1282 20000 C. Martindale



G2 1269 20000 C. Martindale



G2 1253 20000 C. Martindale



G2 1252 25000 C. Martindale

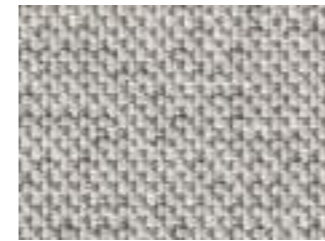

G2 1270 20000 C. Martindale



G2 1271 20000 C. Martindale

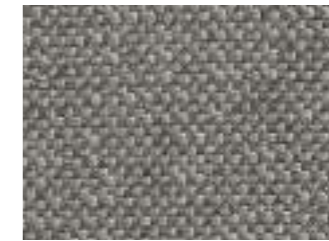

G2 1281 20000 C. Martindale



G2 1295 40000 C. Martindale



G2 1296 40000 C. Martindale



G2 1291 30000 C. Martindale



G2 1297 40000 C. Martindale



G2 1298 40000 C. Martindale



G2 1292 30000 C. Martindale



G2 1301 40000 C. Martindale



G2 1302 40000 C. Martindale



G2 1293 30000 C. Martindale



G2 1299 40000 C. Martindale



G2 1300 40000 C. Martindale



G2 1294 30000 C. Martindale



G3 1288 50000 C. Martindale



G3 1287 50000 C. Martindale



G3 1286 50000 C. Martindale



G3 1290 50000 C. Martindale



G3 1289 50000 C. Martindale



G3 1277 60000 C. Martindale



G3 1283 60000 C. Martindale



G3 1278 60000 C. Martindale



G3 1280 60000 C. Martindale

BATYLINE

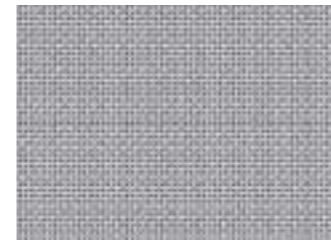

G3 13 120000 C. Martindale

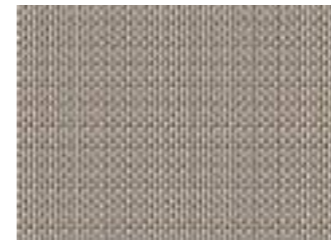

G3 09 120000 C. Martindale



G3 10 120000 C. Martindale



G3 11 120000 C. Martindale



G2 35 120000 C. Martindale

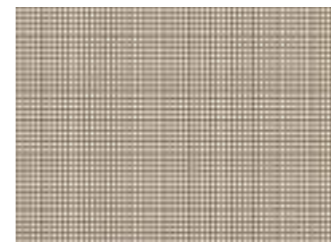

G2 37 120000 C. Martindale

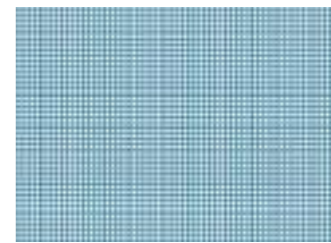

G2 39 120000 C. Martindale

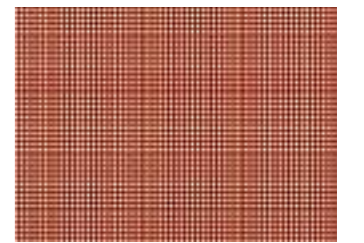

G2 40 120000 C. Martindale

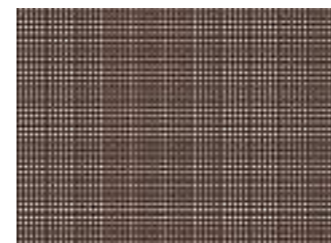

G2 38 120000 C. Martindale



G2 57 120000 C. Martindale

POINT.